

**DEAR CUSTOMER,**  
**Congratulations! You are now the owner of STAB ROTOR SAT.**

**Attention:**

- To connect the motor without interface it is necessary that your receiver includes USALS® or DiSEqC1.2® protocol.
- Please read carefully this instructions manual before installing and using the rotor.
- For more information regarding the commands, see the receiver's instructions manual.

Stab guarantee the complete compatibility and the perfect working in USALS® mode only with receivers which carry this logo:



<b>INDEX</b>	- Technical Data	2
	- Accessories for assembly	2
	- Characteristics of the coaxial cable	2
	- USALS® Information	3
	- Mounting Instructions in USALS® mode	4-6
	- Mounting Instructions in DiSEqC1.2® mode	7-11
	- Accessories	12-13
	- Problem Solving Guide	13
	- Warning - Warranty Conditions - Information	14
	- Maps	71-88
<b>MAPS</b>	- Maps Index	71
	- Norway, Sweden, Finland, Denmark, Baltic Republics	72
	- UK, EIRE	73
	- Nord-Deutschland, Nederland	74
	- Süd-Deutschland, Österreich, Schweiz, Slovenija	75
	- France, Belgique	76
	- España, Portugal	77
	- Italia (nord)	78
	- Italia (sud)	79
	- Maroc, Algerie, Tunisie	80
	- America Central	81
	- Canada	82
	- USA	83
	- Australia, New Zealand	84
	- Polska, Česká Republika, Belarus', Ukrajina	85
	- Slovensko, Magyarország, România, Moldova, Hrvatska,	86
	Bosna i Hercegovina, Jugoslavija, F.Y.R.O. Makedonia,	
	Shqipëria, Bălgarija, Ellás	
	- Rossiya, Qazaqstan, Ukrajina	87
	- Türkiye, Sakartvelo, Suriyah, Al'Iraq, Lubnan, Kipros	88

The USALS® system is a trademark of STAB.

The DiSEqC1.2® system is a trademark of EUTELSAT.

The designs and technical data may be modified without warning and remain the property of STAB.

## ROTOR SAT HH90



Communication protocol	DiSEqC1.2 <sup>®</sup> Level
Maximum dish diameter	95 cm
Maximum dish weight	10 Kg
Diameter of support pole	∅ (35 to 68) mm
Dish support length	145 mm
Dish support diameter	∅ 42 mm
Rotation angle	±65°
Rotation speed	2,4°/s (18V) 1,5°/s (13V)
Operating power supply	13/18 Vdc
Consumption in stand-by mode	40 mA
Consumption in operating mode	180 mA
Starting movement consumption (max)	350 mA
Operating temperature	-40°C +80°C
Maximum relative humidity	100%
Programmable positions (DiSEqC1.2 <sup>®</sup> )	49 satellites
Preset positions (DiSEqC1.2 <sup>®</sup> )	28 satellites
Programmable positions (USALS <sup>®</sup> )	no limits
Connectors	F type
Connection	Coaxial cable
Mechanical limits	±72°
Programmable electrical limits	from 5° to 65°
Fine rotation	by impulses of 0,1°
Inclination of the rotor on the pole	from 10° to 70°
Rotor weight	2,6 Kg

## Accessories for assembly

1 Bracket for anchoring the pole



8 Nuts (8 MA)



1 Nut 8 MA +  
1 Screw M8x35 mm  
(mounting of rotor's pole)



2 U Bolts

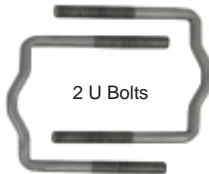

2 Male F Connectors



2 Connectors covers



2 Clamps



2 Screws



1 Key  
(13mm)



## Characteristics of the coaxial cable

Length: to 30 meters (100 feed)

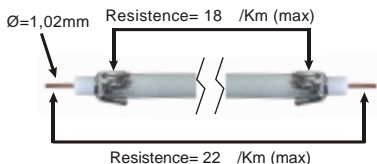

Length: from 30m to 60m (100÷200 feed)

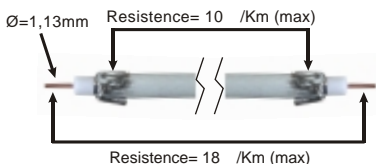

## USALS®

In 1998, thanks to EUTELSAT-STAB collaboration, the DiSeqC1.2® protocol was developed, which can drive all sat motors directly from the receivers.

This system, recognized as a standard by all sat receivers' manufacturers, needs many adjustments to obtain correct installation of the dish (correct pointing to the South, manual research and memorisation of all satellites positions, setting of limits, etc). Since 1999, the main aim of STAB research has been to solve all possible problems connected to installation of the motor and to enable users to buy the STAB motor from their retailer and to install it easily everywhere in the world. With the new USALS® program we can confirm with certainty the achievement of this aim. But what is the USALS® system (Universal Satellite Automatic Location System)? It is a calculation system processed by STAB, and given free to all manufacturers of sat receivers or PC cards, which enables the receiver to calculate the position of all satellites in orbit with a precision lower than 1 meter with reference to the place of installation. All this in a completely automatic mode and with no specific technical knowledge required, either during installation or use.

How to recognise if your receiver is compatible with "USALS®" standard:

1. On the box and on the receiver there must be the  logo.
2. "Motor setting" menu must include the "USALS®" mode.

For further details, please consult the web site: "[www.stab-usals.us](http://www.stab-usals.us)"

Example of calculation of the satellites position with reference to London performed automatically by a receiver implemented with USALS® program:

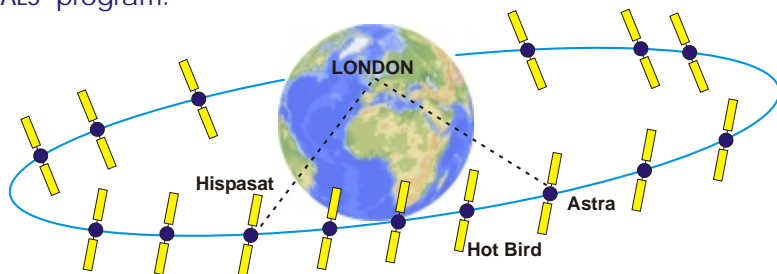

London: **Latitude 51,5°N** - **Longitude 0,0°**

- Astra 19,2°E **Real angle with reference to London = 21,0° anticlockwise**

- HotBird 13°E **Real angle with reference to London = 14,2° anticlockwise**

- Hispasat 30°W **Real angle with reference to London = 32,7° clockwise**

**Dish elevation with Rotor Sat HH90 = 37,6°**

You can get all information about any place in the world only visiting web-site: "[www.stab-usals.us](http://www.stab-usals.us)"

# Mounting Instructions in USALS® mode

1

In order to obtain a correct pointing of the satellites, all systems must be in a perfect plumb line.

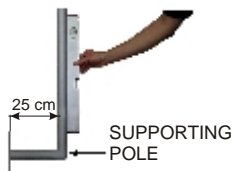

2

**LATITUDE FROM 10° TO 45°**

1 SCREW + 2 NUTS

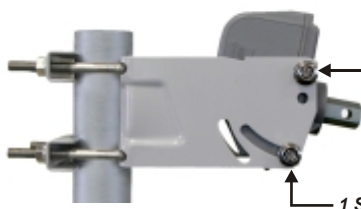

**LATITUDE FROM 45° TO 70°**

1 SCREW + 2 NUTS

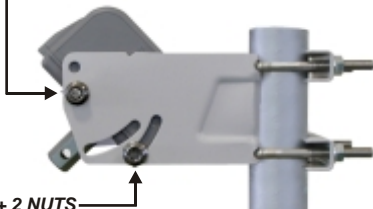

Install the motor only (not the tube at the moment) on the fixing bracket.

3

On a coaxial cable approximately 1,5 m long, set up 2 F-connectors and connect the LNB to the rotor's LNB plug. Fit an F-connector on each end of the cable going to the receiver and connect the rotor's REC plug to the plug of the receiver.

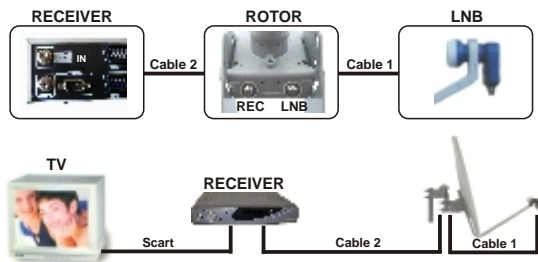

4

Connect the cables to the motor.

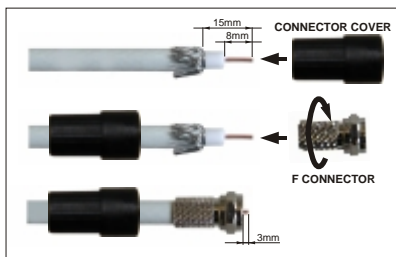

# Mounting Instructions in USALS® mode

The USALS installation procedure is extremely simple. If you are not absolutely certain of the coordinates and the degrees of elevation of the antenna for your installation location, consult the site: [www.stab-usals.us](http://www.stab-usals.us) or the maps at pages 71-88. STAB will provide you with all the data of: **Latitude**, **Longitude**, **Dish Elevation**.

5

**LATITUDE  
FROM 10° TO 45°**

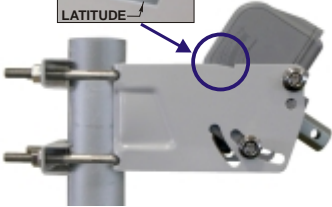

**LATITUDE  
FROM 45° TO 70°**

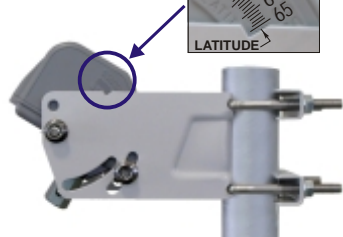

Adjust the rotor inclination to your **Latitude** and tighten the fixing screws.

6

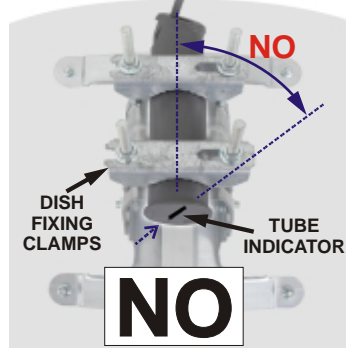
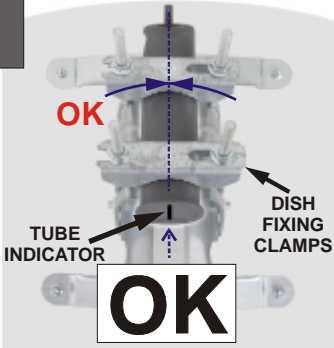

Align perfectly the rotor's tube to the dish axis and tighten the screws.

7

Align the **Dish Elevation** and tighten the fixing screws.

Remove the U-Bolt's exceeding thread.

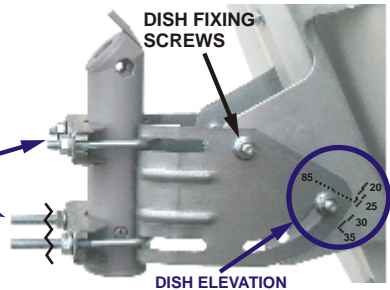

## 8

Insert the tube in its own position on the motor and fix it with the provided screw and nut.

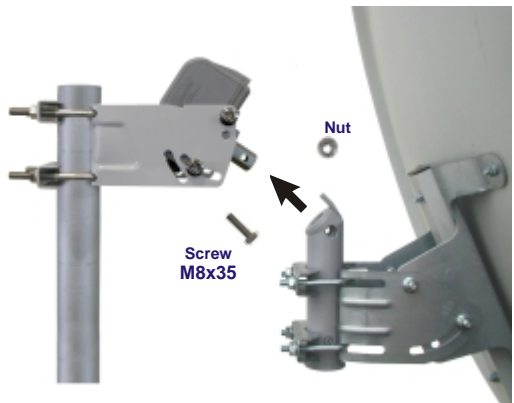

## 9

- See your receiver's instructions manual and select the type of installation in USALS® mode.

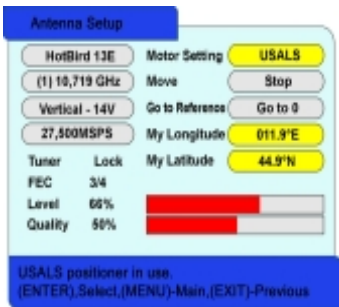

- Choose a satellite the nearest to your South if you lie in the northern hemisphere or choose a satellite the nearest to your North if you lie in the southern hemisphere.

- Fill in the empty spaces in the receiver's menu with the **Latitude** and **Longitude** values previously provided by the web site [www.stab-usals.us](http://www.stab-usals.us) or by the maps on pages 71-88. When the values have been correctly received, the receiver drives the motor to the calculated position.

## 10

Wait until the motor stops. Slightly rotate clockwise or anticlockwise the dish and the motor locked together until you find an image on the TV-screen connected to the receiver or the signal on the strength field meter. Tighten the fixing screws.



### CONGRATULATIONS!!!

Installations and pointing of all satellites  
have just been completed

# Mounting Instructions in DiSeqC1.2® mode

## 1. Where to install the sat dish.

1.1 Choose a position from where the dish can see the SOUTH (if you lie in the northern hemisphere) or NORTH (if you lie in the southern hemisphere) without any impediments or obstructions. Buildings, trees, water-pipes etc. can block partially or completely the sat reception.

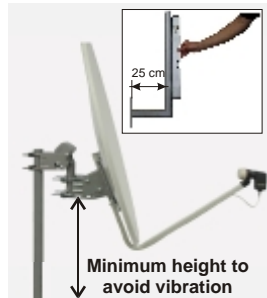

## 2. Rotor's installation.

2.1 Fix the supporting pole ( $\varnothing$  35 ÷ 68 mm diameter) in a perfectly vertical position. Use the provided support to fix the rotor to the pole.

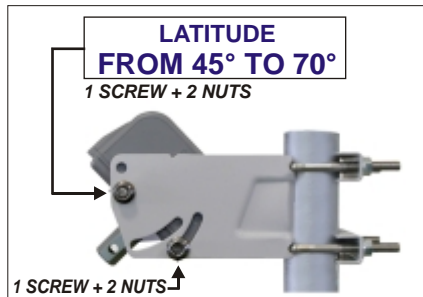
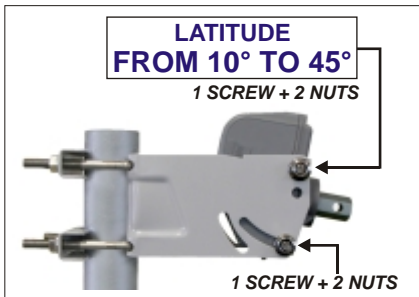

## 3. Connection diagram of the coaxial cable.

An unsuitable cable impairs the correct functioning of the motor! See page 2.

3.1 On a coax cable approximately 1,5 m long, set up two F connectors and connect the LNB to the rotor's LNB plug. Fit an F-connector on each end of the cable going to the receiver and connect the rotor's REC plug to the plug of your receiver.

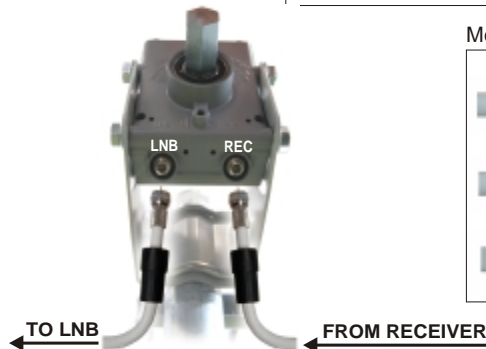
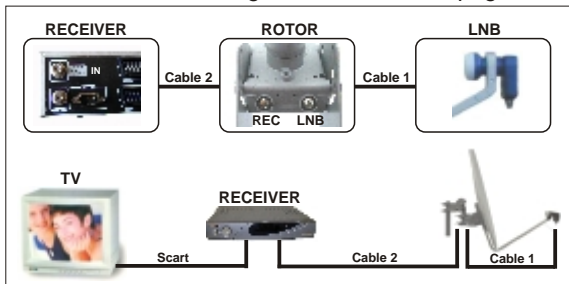

## Mounting of F connectors

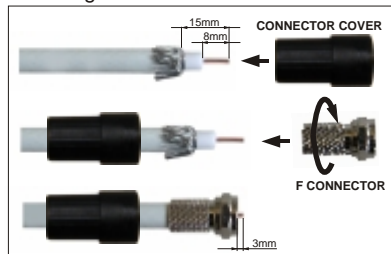

## 4. How to find out the elevation angle of the Rotor

4.1 Find out your own geographical position on the map on page 71-88, note the latitude value and set the rotor angle to this value:

(from 10° to 45° - fig.1a) (from 45° to 70° - fig. 1b)

**Example1:** - Madrid 40,4° Latitude NORTH LATITUDE= 40,4° (fig 1a)

**Example2:** - Venice 45,5° Latitude NORTH LATITUDE= 45,5° (fig 1b)



## 5. Tube's installation

5.1 Align perfectly the rotor-s tube to the dish axis and tighten the screws.

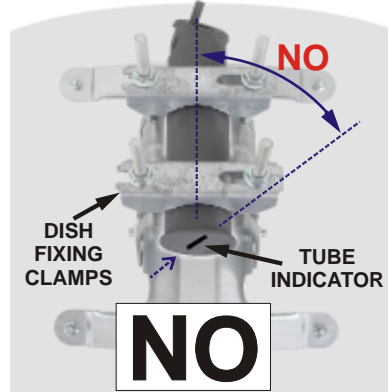
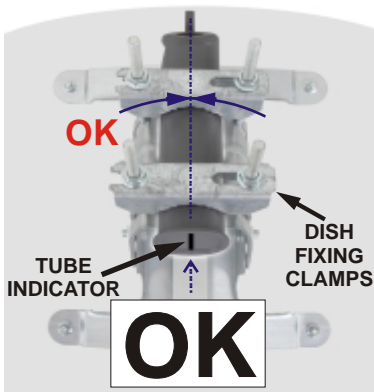

## 6. How to find out the elevation value of the dish

6.1 With the same latitude value, calculate the elevation of the dish according to the following formula:

**Degrees of dish elevation = P - (45 - latitude)**

*P = degrees of dish elevation for fixed mount given by the manufacturer.*

**Example:- Latitude Venice = 45,5°**

*P (dish elevation given by the manufacturer) = 37,6*

*Degrees of dish elevation = 37,6 - (45 - 45,5) = 38,1° (fig.2)*

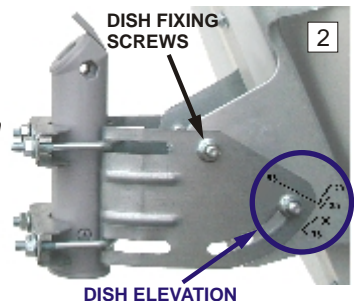



# Mounting Instructions in DiSeqC1.2® mode

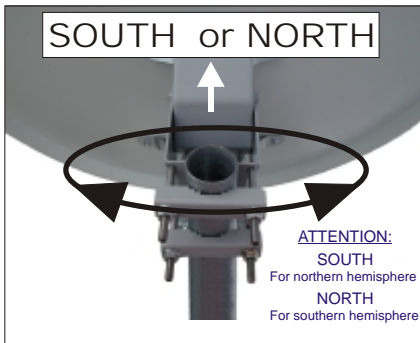
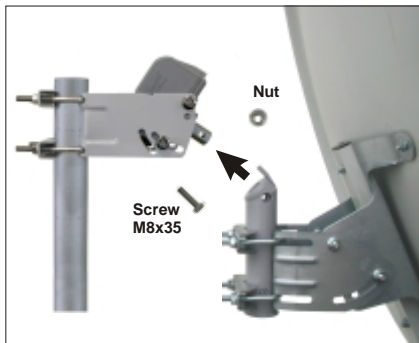

**6.2** Insert the tube in its own position on the motor and fix it with the provided screw and nut.

**6.3** Point the rotor position to the south using a compass.

## 7. Dish pointing.

**7.1** To point your dish easily, refer to the satellite the nearest to your longitude (see maps on page 71-88).

**7.2** Calculate the difference between the reference satellite and your position considering that:

- positive values = Anticlockwise moving

negative values = Clockwise moving.

Ex 1: - Installation VENICE (*longitude 12,3° East*) - Reference satellite ASTRA (*longitude 19,2° East*)  
 $19,2 - 12,3 = +6,9$  **The position of ASTRA from Venice is: 6,9° Anticlockwise (see fig 3).**

Ex 2: - Installation VENICE (*longitude 12,3° East*) - Reference satellite Eutelsat F2 (*longitude 10° East*)  
 $10 - 12,3 = -2,3$  **The position of EUTELSAT from Venice is: 2,3° Clockwise.**

**7.3** With the receiver's remote control (see receiver's instructions manual - paragraph dedicated to the motor), move the rotor by short impulses Eastwards or Westwards to reach the calculated value. To coordinate this operation it is necessary that the receiver is near the dish or that somebody can assist you: while the first one uses the remote control near the receiver, the other one will inform when the dish has reached the correct position on the graduated scale of the rotor.

Example: VENICE - around 6,9° EAST (for Astra) - fig. 3

**7.4** Disconnect the cable going to the receiver from the rotor and connect the field-strength meter. Unscrew the bolts that hold the rotor to the main pole and then rotate EASTWARDS or WESTWARDS both the rotor and the dish locked together (fig. 4 - Bolts ) until you obtain the best reception quality; tighten then again the bolts. If you cannot use a field-strength meter, you need anyway to place a TV near the dish to check the image definition. Connect the rotor again.

**7.5** Store the sat position (see receiver's instructions manual - paragraph dedicated to the motor), then operate a recalculation "see paragraph 9.2" (if your receiver enables this function); otherwise find out the other sat positions and store them one by one. If the previous steps have been correctly carried out, you should now be able to see all satellites including the lower East and West orbital ones.

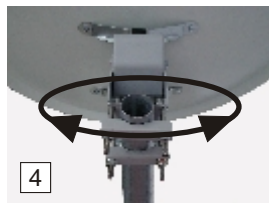
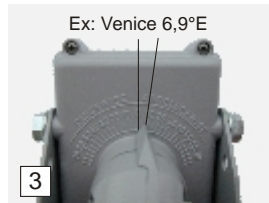

# Mounting Instructions in DiSEqC1.2® mode

## 8 Fine tracking.

**8.1** If this procedure was not carried out properly, you might experience imperfect reception of the satellites in the most eastwards and westwards positions. To correct this, you must proceed as follows: - select a non-encrypted channel on the most Eastward satellite, then bend slightly the dish upwards / downwards without loosening any bolts and check if there is any picture improvement. Repeat the same procedure also with the most Westward satellite. In these conditions four possible cases could occur:

**8.2 Case nr 1** - If there is a picture quality improvement while bending up the dish on the Eastward sat position and bending down on the Westward sat position unscrew slightly the bracket and rotate westwards (clockwise) the rotor and the dish locked together. Tighten the screws of the supporting bracket, then correct the dish orientation and go to the reference satellite by using the receiver's remote control (see receiver's instructions manual - paragraph dedicated to the motor). Find the best picture and store the new position. Now you can operate the recalculation (if your receiver gets the function). If not, you have to go back to each memorized position, check the best picture and store all positions one by one.

**ATTENTION:**

**SOUTH**  
For northern hemisphere

**NORTH**  
For southern hemisphere

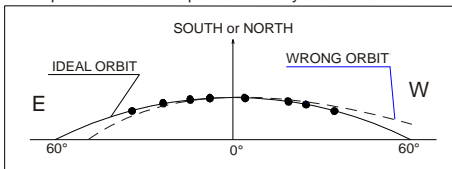

**8.3 Case nr 2** - If there is a picture quality improvement while bending up the dish on the Westward sat position and bending down on the Eastward sat position unscrew slightly the bracket and rotate eastwards (anticlockwise) the rotor and the dish locked together. Tighten the screws of the supporting bracket, then correct the dish orientation and go to the reference satellite by using the receiver's remote control (see receiver's instructions manual - paragraph dedicated to the motor). Find the best picture and store the new position. Now you can operate the recalculation (if your receiver gets the function). If not, you have to go back to each memorized position, check the best picture and store all positions one by one.

**ATTENTION:**

**SOUTH**  
For northern hemisphere

**NORTH**  
For southern hemisphere

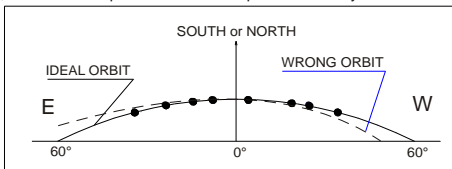

**8.4 Case nr 3** - If the picture quality improves while bending the dish Up/East on the Eastward sat position and Up/West on the Westward sat position, you should unscrew the motor support from the pole and lower slightly the elevation of the complete system. Find the best picture and store the new position. Now you can operate the recalculation (if your receiver gets the function). If not, you have to go back to each memorized position, check the best picture and store all positions one by one.

**ATTENTION:**

**SOUTH**  
For northern hemisphere

**NORTH**  
For southern hemisphere

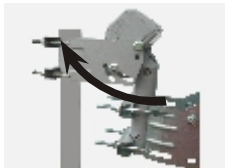
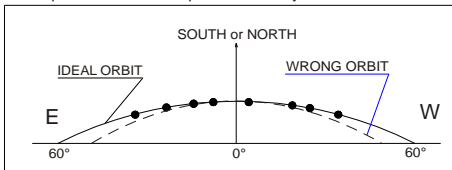

**8.5 Case nr 4** - If the picture quality improves while bending the dish downwards/both eastwards and westwards, you should loosen the rotor's fixing screws and increase slightly the elevation on the bracket. Find the best picture and store the new position. Now you can operate the recalculation (if your receiver gets the function). If not, you have to go back to each memorized position, check the best picture and store all positions one by one.

**ATTENTION:**

**SOUTH**  
For northern hemisphere

**NORTH**  
For southern hemisphere

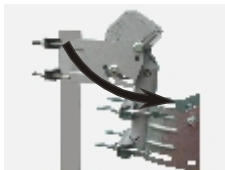
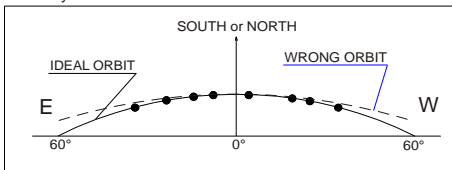

## 9. EAST - WEST limits (only for enabled receiver).

- 9.1 The rotor is designed to rotate from 65° Anticlockwise to 65° Clockwise.
- 9.2 Two limits are set electronically at  $\pm 65^\circ$  and mechanically at  $\pm 70^\circ$  to protect the maximum rotation. Within these limits you can though set two new electronic limits included between  $5^\circ \div 65^\circ$  EAST and  $5^\circ \div 65^\circ$  WEST; over these ranges the motor does not accept any memorization.
- 9.3 Setting the limits might become necessary if the rotor cannot perform the full rotation because of an obstacle.
- 9.4 To remove, to set and to store the limits, see the receiver's instructions manual on the paragraph dedicated to the limits.
- 9.5 If not really necessary, please maintain the limits in the pre-programmed positions at  $\pm 65^\circ$ .

## 10. Recalculation function (only for enabled receivers).

- 10.1 The rotor includes 49 satellites positions: 28 positions are preset, as shown on the table below, and 21 still available.

Pos nr	Satellite	Position	Pos nr	Satellite	Position
1	Hot Bird	13°E	15	Orion	37°W
2	Astra	19,2°E	16	Kopernicus 3	23°E
3	Eutelsat F3	16°E	17	Arabsat 2A	26°E
4	Eutelsat F2	10°E	18	Kopernicus 2	28°E
5	Eutelsat F4	7°E	19	Astra 2	28°E
6	Sirius	5°E	20	Arabsat 2B	30°E
7	Telecom 2C	3°E	21	Turksat 1B	31°E
8	Intelsat 707	1°E	22	Turksat 1C	42°E
9	Telecom 2B,2D	5°W	23	Intelsat 601	34,5°E
10	Telecom 2A	8°W	24	Pas 1	45°W
11	Intelsat 705	18°W	25	Amos	4°W
12	Intelsat Star	21°W	26	Thor	0,8°W
13	Intelsat 803	27°W	27	Nilesat	7°W
14	Hispasat	30°W	28	Eutelsat	12,5°W

- 10.2 The recalculation function automatically calculates and sets all pre-programmed satellites positions with reference to the position of a single satellite. In other words after you have found and stored the first satellite, the recalculation procedure enables the automatic re-positioning of the other satellites inside the rotor's memory to a pre-defined distance, as shown on the above table. The re-calculation procedure must be operate only on the first satellite stored (the others excluded).

## 11. Return to the 0 position of the rotor (only for enabled receivers).

- 11.1 This function enables the rotor to return to the 0° position and to reset the inside counter. It is very important to re-align all satellite positions that can be slightly slided eastwards or westwards from the reference stored positions (bad picture or lost positions).
- 11.2 In the receivers' menu this function could be named as: - RE-ALIGN - RESET - GO TO POS 00 - REFERENCE. In some receivers this operation is automatic.
- 11.3 After this command, check if the satellite positions are correct.
- 11.4 If this function is not implemented in your receiver, you need to connect temporarily an interface and press the remote control buttons "FUNC and RESET".

## 12. Autofocus (only for enabled receiver).

- 12.1 The rotor is provided with a special function called "autofocus": this procedure allows the rotor to focus automatically the satellites before storing. Only some receivers are provided with this command.

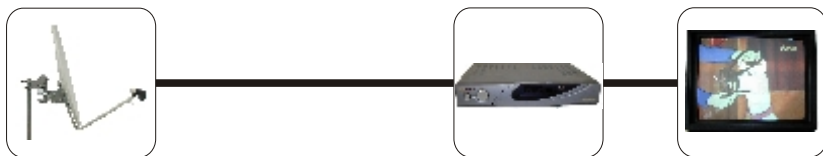

DiSEqC1.2® / USALS® receivers configuration.

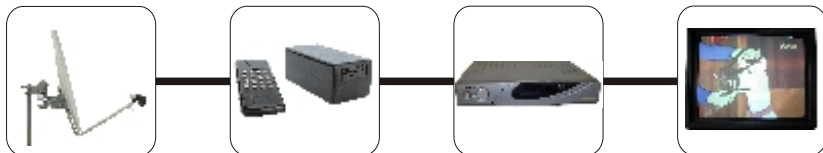

MS220 interface configuration for receivers without DiSEqC1.2® / USALS®.

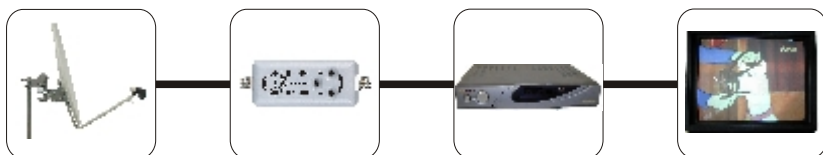

MP02 Minipos configuration for DiSEqC1.0® receivers.

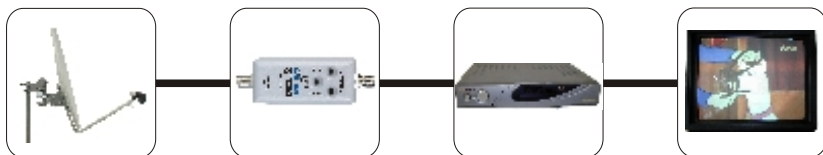

MP01 Minipos configuration for DiSEqC1.2® receivers without reset (Go to 0).  
Pointing antenna configuration for installer.

## MP01

The mini-positioner "Rotor Control MP01" is an indispensable tool needed by the installer when pointing the dish in DiSEqC1.2® mode.

Easy to use, in 5 minutes it enables the dish to be perfectly pointed only with the help of the strength field meter.



## MP02

The mini-positioner "Rotor Control MP02" allows for storage and automatic recall of 4 sat positions directly from a PC-Card or a DiSEqC1.0® receivers.



# HH100

Motor Sat for 100 cm (max) dishes.



# HH120

Motor Sat for 120 cm (max) dishes.



## Problem solving guide

**WARNING! NEVER SWITCH OFF THE RECEIVER WHILE THE MOTOR IS MOVING TO AVOID THE LOSS OF ALIGNMENT.**

PROBLEM	CAUSE	REMEDY
1. The rotor does not rotate.	<ul style="list-style-type: none"> <li>The receiver is blocked.</li> <li>Oxidised connectors.</li> <li>Coaxial cable badly wired.</li> </ul>	<ul style="list-style-type: none"> <li>Reset the receiver, or disconnect it from the mains for 30 seconds.</li> <li>Substitute connectors.</li> <li>Check F connections on the cable.</li> </ul>
2. The rotor slightly exceeds the stored sat positions (disturbed pictures).	<ul style="list-style-type: none"> <li>The receiver has been switched off many times while the rotor was moving.</li> <li>Electrical micro-interruptions.</li> </ul>	<ul style="list-style-type: none"> <li>Send re-alignment command (parag.11)</li> </ul>
3. The rotor lost all satellites positions (no picture).	<ul style="list-style-type: none"> <li>The rotor received a command wrongly.</li> </ul>	<ul style="list-style-type: none"> <li>Find a satellite and operate the re-calculation function (only for enabled receivers - parag. 10), or store again all sat positions one by one.</li> </ul>
4. The rotor is blocked at the extremes.	<ul style="list-style-type: none"> <li>The receiver sent a wrong command.</li> </ul>	
5. The rotor does not rotate beyond a certain position.	<ul style="list-style-type: none"> <li>A limit has been set and stored on this position.</li> </ul>	<ul style="list-style-type: none"> <li>Remove the limits and store them again in more appropriate positions (parag.9).</li> </ul>
6. The rotor does not focus the sat positions even after the recalculation procedure (only for enabled receivers).	<ul style="list-style-type: none"> <li>The dish pointing procedure was not carried out correctly.</li> <li>Latitude and/or Longitude of installation place, not precise or wrong.</li> </ul>	<ul style="list-style-type: none"> <li>Repeat dish pointing procedure following carefully the instructions on parag. 7 "DISH POINTING".</li> </ul>
7. Extreme East/West satellites signals are not received.	<ul style="list-style-type: none"> <li>Wrong setting of rotor's elevation angle.</li> </ul>	<ul style="list-style-type: none"> <li>Repeat more carefully the procedures on parag. 8.</li> </ul>
8. Central satellites signals are not received.		

## Warning

- Only a specialist can guarantee a correct mechanical installation which will avoid damage or serious injury.
- The motor must not be mounted upside-down.
- For mounting, all the screws and nuts contained in the kit must be used. The absence of one screw or nut may cause instability or the fall of the equipment.
- The motor has been tested for resistance in wind conditions of 140 Km/h with a dish of 100 cm, so care must be taken in choosing the supporting pole and its anchorage. If possible, installation should be carried out in a place sheltered from wind (rooftops are never advisable).
- The use of dishes with a larger diameter than that indicated in the specifications for each motor is strictly prohibited.
- The motor, being a mechanical rotating instrument, must be installed out of reach of people.
- The motor must not be used for purposes other than those indicated by STAB.
- The motor has been designed to be supplied by a sat receiver or by a STAB positioner; any other type of supply is strictly prohibited and may cause damage or serious injury.
- Some receivers have an anti-disturbance system linked to the body of the connector F. This may provoke a slight electric shock not dangerous for the user. In particular conditions (e.g. on a roof or on a staircase) it may cause falls or injuries. Each time the motor is handled the receiver must be disconnected from the outlet.

## Warranty conditions

This rotor is produced and tested by our laboratory with extreme care and carries a warranty for 36 months from purchase date. A copy of the shop receipt or the invoice represent the warranty document and must be sent together with the set when returned. This warranty covers all production defects and working faults, but excludes all damages caused by drops, incorrect use or external oxidations due to incorrect installation. Any repair made by unauthorised personnel will automatically cancel this warranty.

**PLEASE FILL IN THIS FORM WITH THE SERIAL NUMBER OF THE MOTOR IN CASE OF AFTER SALES OR TECHNICAL ASSISTENCE.**

**SERIAL NUMBER**

--	--	--	--	--	--	--	--	--	--

## Information

**For further information and advice about installation and uses contact**

**YOUR LOCAL DEALER or  
STAB Technical Office:**

**Via Seminiato, 79 - 44031 Ambrogio (FE) - ITALY  
Local time 8.00 to 12.00 a.m. and 1.30 to 5.30 p.m. (MIDDLE EUROPE time)  
Phone +39-0532-830739 Fax +39-0532-830609**

<http://www.stab-italia.com>

e-mail: [sandro@stab-italia.com](mailto:sandro@stab-italia.com)