

## Introduction



This kit allows evaluation of the Intersil PRISM® II Direct Sequence chip set design in a Wireless Local Area Network (WLAN) PCMCIA Card implementation.

Software drivers are included allowing data to be transmitted between cards at 1, 2, 5.5 and 11Mbps transfer rates, with a diagnostic program to display the real data throughput from system to system.

Included in the kit are PRISM II chip set data sheets with application notes describing the implementation of a wireless networking card using the chip set.

### Contents of Your Evaluation Kit

Your PC Card Wireless LAN Evaluation Kit contains the following items:

QUANTITY	DESCRIPTION
2	PRISM II Wireless LAN PC Cards
1	HWB3163 Wireless LAN Evaluation Kit User's Guide, AN9864
1	PRISM II Chip Set Data Sheets
1	PRISM II Application Notes
1	Microsoft® Windows® 95/98/NT/CE/2000, LINUX® Driver
1	PRISM® Test Utilities (PTU) Software
1	Features/Benefits Card
1	Product Registration Form
1	Notification Card

Should you discover that your PC Card Wireless LAN Evaluation Kit is incomplete, please contact Intersil Corporation.

### Overview of IEEE 802.11

The IEEE 802.11 specification is a standard for wireless connectivity for fixed, portable, and moving stations within a local area.

The IEEE 802.11 standard describes the services required by a compliant device to operate within an "ad hoc" or "infrastructure" network, as well as dealing with the issues related to mobility within those networks. Spread spectrum techniques are used to tolerate mobility and multipath effects. They are also a requirement for compliance with FCC, ETSI and those of other regulatory authorities when operating within the Industrial, Scientific, and Medical (ISM) frequency band.

An *ad hoc* communications network is created quickly and informally for a temporary time period. An infrastructure network usually requires more planning so that wireless stations can communicate over longer distances through access points, and may also communicate with existing wired LANs using portals.

The IEEE 802.11 standard describes Media Access Control (MAC) procedures. The principal method of communication is the Carrier Sense Multiple Access with Collision Avoidance (CSMA-CA) protocol. Using this protocol, each station senses the communications medium (RF channel), and does not transmit until the channel is clear. This avoids collisions and minimizes the retransmission of subsequent packets.

The standard also supports the operation of a station within a wireless LAN that may coexist with several overlapping wireless LANs. To accomplish this, a scheme of channelization and spread spectrum techniques is used. Direct Sequence (DSSS) and Frequency Hopping (FHSS) spread spectrum techniques are supported by the standard and both operate in the 2.4 to 2.4835GHz frequency band (the unlicensed ISM band). An infrared technique is also supported for indoor applications. The standard supports a 1Mbps and 2Mbps data rate for both DSSS and FHSS and has recently introduced a high data rate standard supporting 5.5Mbps and 11Mbps DSSS using Complementary Code Keying (CCK) modulation.

The standard has also specified the requirements and services that enable private and secure communications to occur.

### Wireless LAN Configurations

For ease of use in evaluating these cards, an *ad hoc* network for peer to peer communications can be created. An *ad hoc* network is usually created for a specific purpose (such as file transfer or accessing a database). *Ad hoc* networks simplify the process of creating and dissolving networks for nontechnical users of the network facilities. Two cards form an IEEE 802.11 Independent Basic Service Set (IBSS), the simplest *ad hoc* network. The cards communicate with each other directly and must remain within radio range. When both cards are on, they immediately "see" each other and the *ad hoc* network is formed without user intervention.

To use the cards in an infrastructure BSS (also called an Extended Service Set) where the two cards may not be in direct radio contact, access points are needed. The association between a card (station) and an infrastructure BSS - where communication occurs only between a station and an access point and not between stations directly is dynamic.

The IEEE 802.11 protocols are implemented in the firmware so that file transfers or database access can begin immediately.

### **Direct Sequence Spread Spectrum Approach**

The use of spread spectrum techniques for wireless computer communications is widely accepted because of its robustness against multipath effects and interference from intentional or unintentional radiators. The use of spread spectrum techniques in the ISM frequency band also allows products to be deployed without the need for an FCC license.

The two main methods by which spread spectrum communications can be achieved are Direct Sequence Spread Spectrum (DSSS) and Frequency Hopping Spread Spectrum (FHSS). This wireless LAN PC card uses the DSSS technique. DSSS transmission has the best performance in terms of multipath immunity and jamming rejection. In an office environment, jamming sources are likely to be unintentional such as emissions from microwave ovens. Even though unintentional, they pose a threat to the communications network. Direct sequence techniques are superior to frequency hopping systems in this case because FHSS gains its immunity to jamming by avoiding the location of a single tone jammer (such as other FHSS users). When collisions occur, data is lost. With a DSSS system, the despreading function in the receiver gives immunity to jamming by spreading the interfering energy by the Pseudo Random Number (PN) code over the whole bandwidth. This selective despreading attenuates the jamming power while despreading the desired signal.

In the office environment, multipath effects may degrade network communications. Direct sequence techniques offer better protection than slower frequency hopping systems in the presence of multipath interference. With frequency hopped systems, if the hopper jumps to a frequency where a null resides, then data is lost until the next hop. Multipath signals can be thought of as a special case of unintentional jamming. In the DSSS approach, nulls resulting from multipath fading only eliminate a fraction of the signal power since the bandwidth in the DSSS case is very large. A significant amount of energy still remains in the signal and effective despreading still occurs. The probability of burst errors is reduced significantly.

An often overlooked factor when comparing IEEE 802.11 compliant DSSS and FHSS implementations, is the achievable data rate. A frequency hopping occupied bandwidth of 1MHz as specified by the FCC acts as a limitation when using data rates beyond 2Mbps. A similar bandwidth limitation has not been imposed when using the direct sequence implementation. In the new 802.11 high data rate (11Mbps) standard utilizing Complementary Code Keying (CCK) modulation, the 5-1/2 times increase in data rate has been achieved in the same 17MHz bandwidth! This

is accomplished by encoding 6 bits of data in one out of a possible 64 orthogonal PN spreading sequences. More information on the new high data rate standard may be found in Applications Note AN9850 "Complementary Code Keying Made Simple" which may be found on the Intersil Web Site.

### **Installation of HWB3163 Windows 95/98 Drivers**

- Step 1. With the PRISM PCMCIA card removed, boot your PC under Microsoft Windows 95 or 98.
- Step 2. Once your system has booted and is idle, insert **PRISM II Driver for Windows, Disk #1** into the "A" Floppy Drive. On the Desktop, left click on **<Start> -> <RUN>** then type **A:SETUP <Enter>** Follow the on-screen instructions. Accept all defaults.
- Step 3. When the preliminary installation is complete, insert the wireless LAN PC card in the lower PCMCIA slot (see *Hardware Installation* below).
- Step 4. Windows should automatically recognize that the card has been inserted. It then displays a dialog box titled "New Hardware Found".
- Step 5. Insert **PRISM II Driver for Windows, Disk #1** into the floppy drive. Tell Windows that the driver is located on drive "A". Accept all defaults.
- Step 6. Follow the on-screen instructions to complete installation of the driver. When complete, the NDC driver icon should appear in the system area on the desktop (computer monitor with antenna). Clicking on this icon enables setting of channel, mode, etc.
- Step 7. If operating in the Pseudo IBSS mode, you must assign a unique IP address to the computer in order for the card to be operable. Left click on **<Start> -> <Settings> -> <Control Panel>** . Double click on **Network**. Select **TCP/IP ... PRISM IEEE 802.11 PC Card ...** and click on **Properties**. Select the **IP Address** tab. Click on **Obtain an IP Address**. Enter a valid IP address. Enter a valid Subnet Mask (suggest 255 255 255 0). Click on **OK**.

### **PRISM Test Utility (PTU) Software Installation**

NOTE: Perform after Windows Driver Installation.

- Step 1. Insert the PTU disk #1 into the floppy drive.
- Step 2. On the Desktop, left click on **<Start> -> <RUN>** then type **A:setup <Enter>**. Follow the on-screen instructions. Accept all defaults. When the installation is complete, an icon should automatically appear on the Desktop.

**Hardware Installation**

- Step 1. Ensure that power to the PCMCIA slot is OFF by noting that the PCMCIA icon does not appear in the System Tray on the Desktop. If unsure, re-boot the computer.
- Step 2. Insert the wireless LAN PC card extender card into the PCMCIA slot.
- Step 3. Insert the wireless LAN PC card into the end of the extender card. Ensure that the LED and pin headers of the extender card are on the same side. Both the card and the extender are keyed so they will fit correctly. The HWB3163 is a 3V only device. Do not therefore force it in a 5V-keyed system as permanent damage may occur.

INSTRUMENT	MANUFACTURER	MODEL
Frequency Counter	Hewlett-Packard	53181A (012 Option)
Digital Scope		
General-Purpose Multimeter		
Computer with a PCMCIA Connection Slot (2 required)		
3V PCMCIA Extender Card	Swart Interconnect	EXT PCM-68-CC NOTE: This is a 5V Extender and must be mechanically modified for 3V operation)
Differential Probe	Tektronix	P6247
RF Probe, 500Ω	Hewlett-Packard	54006A + 11742A

**PC Card Evaluation**

This chapter describes several software programs supplied with the kit. It also details some diagnostic test points that may be accessed on the card.

**Using the PRISM Test Utility (PTU) Software**

The PTU permits continuous operation of the transmitter. It is therefore convenient for performing RF measurements such as Transmitter Power. It also provides a handy method of changing channels within the ISM band, Use of the PRISM Transmitter Test Utility is basically self explanatory. An icon was automatically created on the desktop when the PTU installation was performed. It may be run by double-clicking on this icon.

**Using the LANEVAL Software**

LANEVAL provides a convenient method of analyzing Packet Error Rate (PER) and Receiver Sensitivity. An icon for starting LANEVAL was automatically placed on the desktop when the PTU installation was performed. In order for LANEVAL to form a successful link, the same packet parameters (e.g., Packet Length, Packet Pad Words, etc.) must be programmed at each end of the link.

LANEVAL runs in conjunction with the NDC Driver. The Driver permits selection of Data Rate and Channel. It is normally run in the *Pseudo IBSS* mode as this provides a simple wireless Ad Hoc link between two computers. The NDC Driver may be easily accessed by double-clicking on its icon (looks like a computer with an antenna on top) located in the System Tray area on the desktop.

**List of Test Instruments**

The following instruments may be used for conducting tests on the wireless LAN PC card.

INSTRUMENT	MANUFACTURER	MODEL
Spectrum Analyzer	Hewlett-Packard	8595E
Power Meter	Giga-tronics	8541B
Signal Generator	Hewlett-Packard	8648C

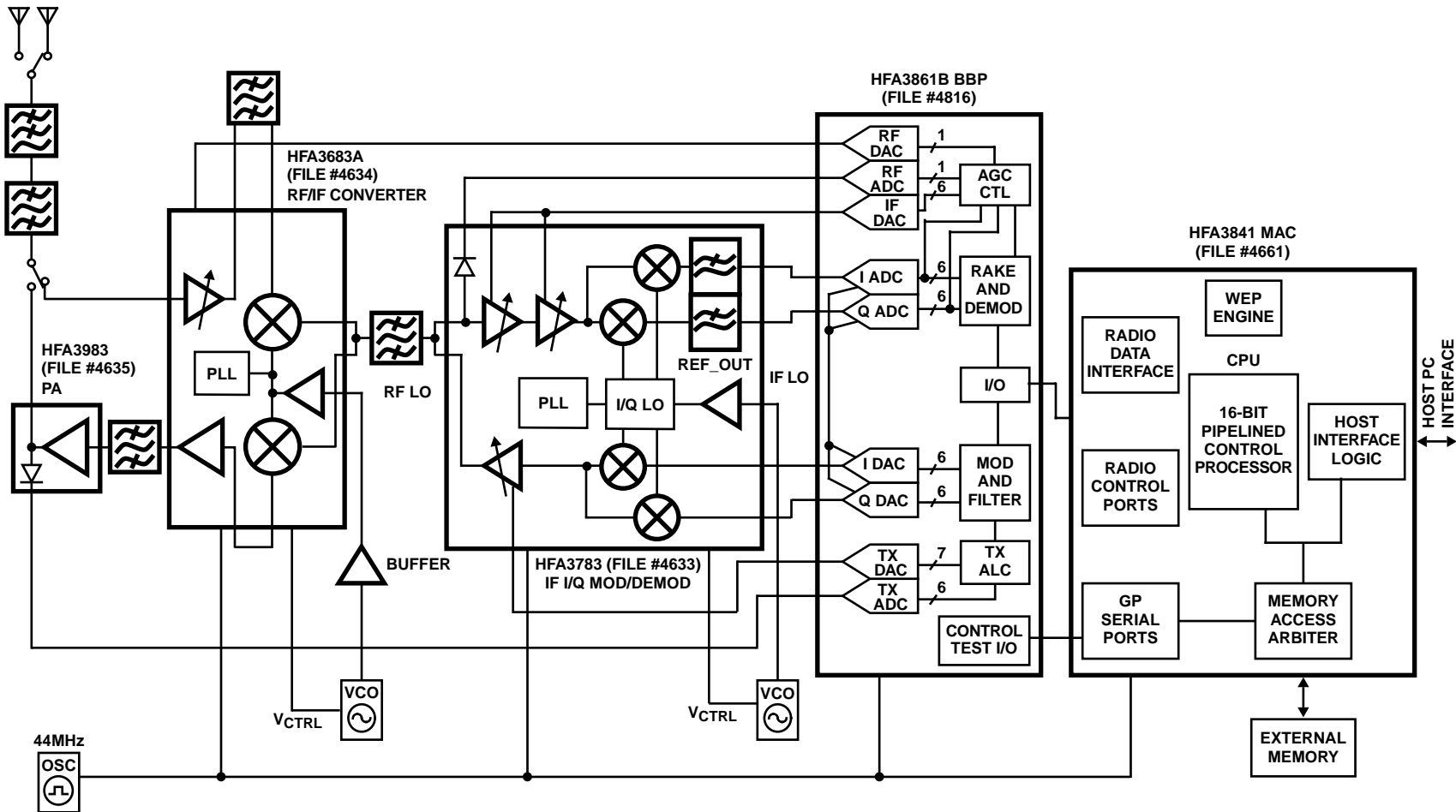

FIGURE 1. WIRELESS LAN PC CARD BLOCK DIAGRAM

Test Point Diagrams

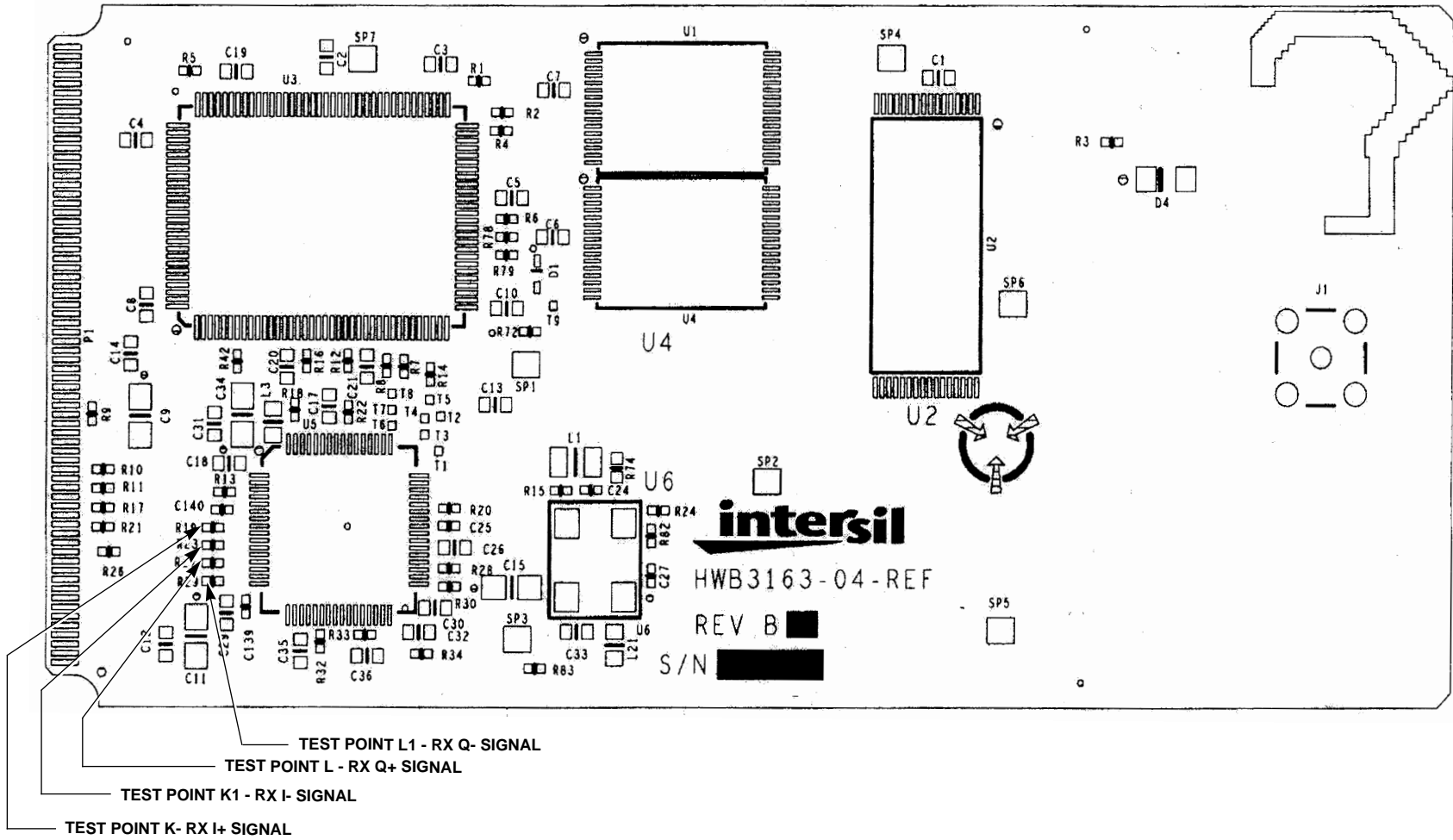

FIGURE 2. WIRELESS LAN PC CARD TEST POINTS (TOP VIEW)

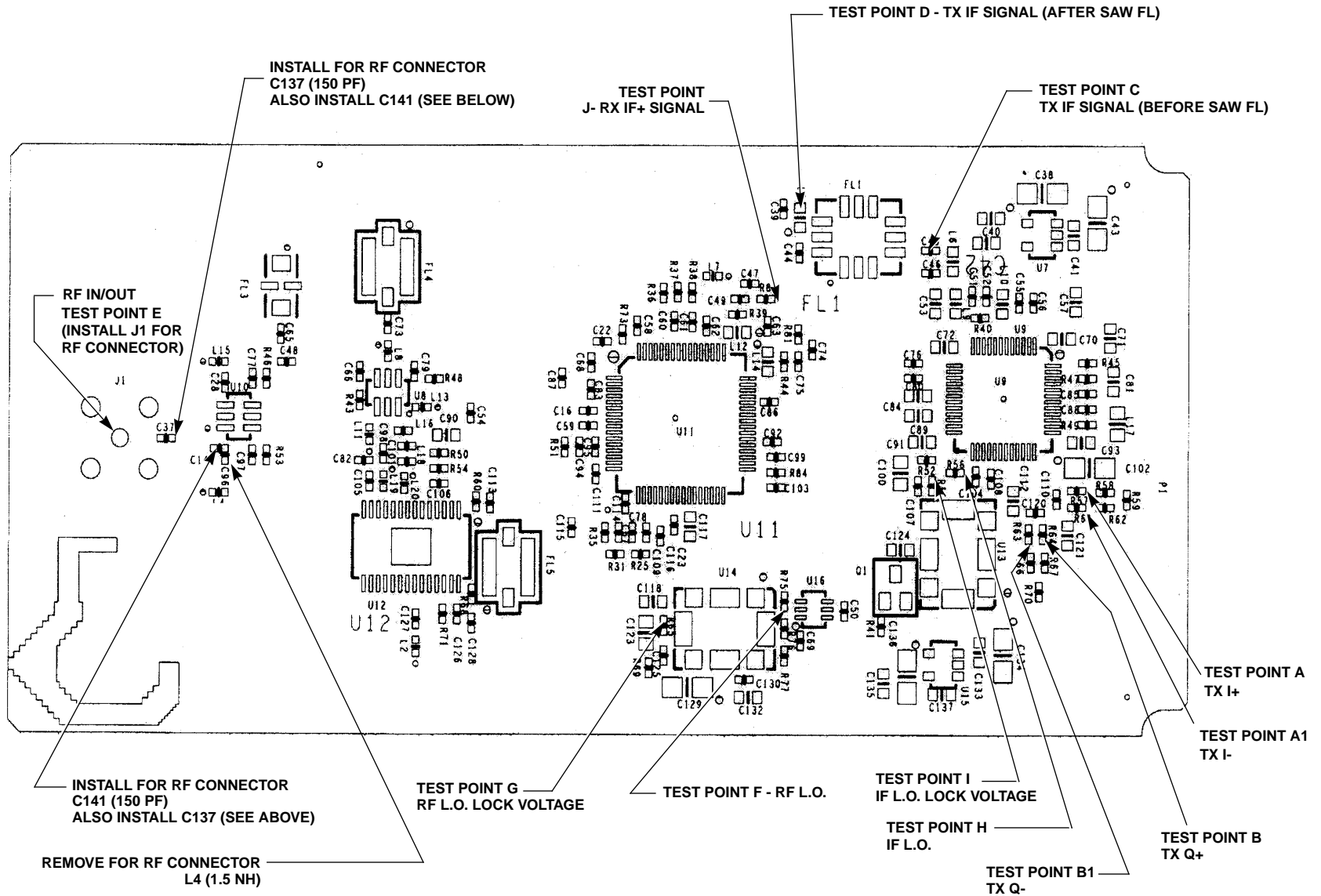

FIGURE 3. WIRELESS LAN PC CARD TEST POINTS (BOTTOM VIEW)

### Explanation of Test Points

All measurements were taken using the "Continuous Transmit" or "Continuous Receive" features of the PTU diagnostic software. Unless otherwise noted, spectrum measurements included in this section were obtained using a Hewlett-Packard 54006A 500Ω probe and 11742A coaxial blocking capacitor and do not indicate the actual amplitude of the signal owing to losses associated with the probe. Unless noted, 11Mbps CCK modulation was employed.

Many of the signals are differential (i.e., balanced with respect to ground). These are denoted by + (plus) and - (minus) symbols following the signal name (e.g., RX I+ and RX I-).

### Test Points A- A1, and B-B1

Transmit I and Q:

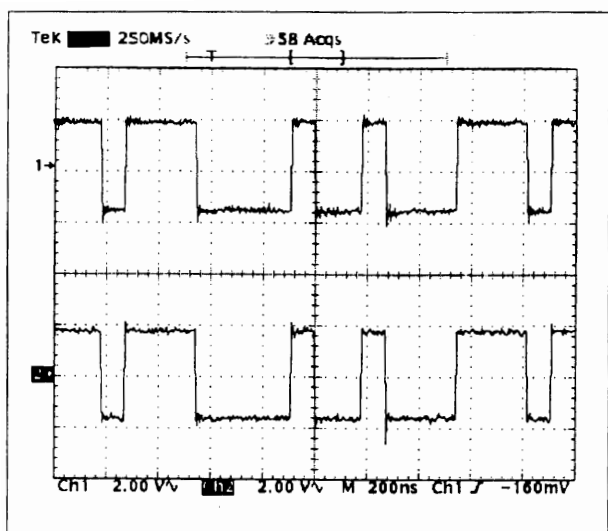

FIGURE 4. TRANSMIT I AND Q SIGNALS AT THE OUTPUT OF THE HFA3861 (TEST POINTS A-A1 AND B-B1)

NOTE: BPSK mode is used for the plots in this figure. Therefore, I and Q are identical.

The I and Q are both differential signals and, as such, consist of I+, I-, Q+, and Q- respectively. As these are balanced signals, data is measured using a Tektronix P6247 Differential Probe. For example in the measurement of the I signal, the probe is bridged between Test Points A (I+) and A1 (I-).

Transmit In-phase and Quadrature (I+ and Q+) signals are the spread baseband single-bit I and Q digital data that are outputted at the programmed chip rate (N).

### Test Points C and D

IF Transmit Signal:

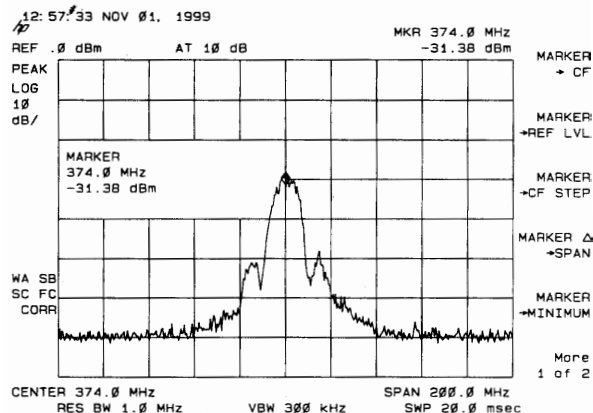

FIGURE 5. IF TRANSMIT SIGNAL BEFORE SAW FILTER (TEST POINT C)

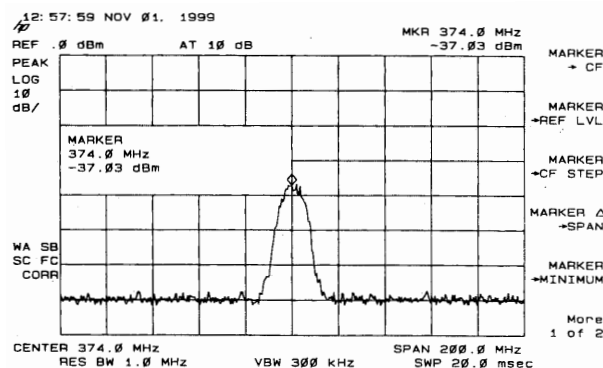

FIGURE 6. IF TRANSMIT SIGNAL AFTER THE SAW FILTER (TEST POINT D)

The intermediate frequency (IF) transmit signal is a spread spectrum signal centered at 374MHz with a 17MHz bandwidth.

The SAW filter is used to shape the sidelobes.

Test point C is at the input of the SAW Filter whereas D is at the output.

**Test Point E**

RF Transmit Signal:

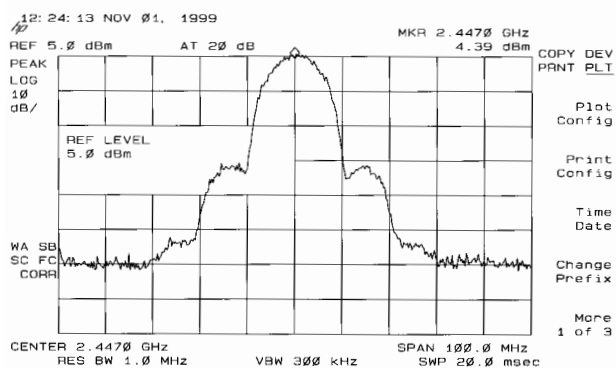

**FIGURE 7. TRANSMITTED 2.4GHz SIGNAL SPECTRUM (TEST POINT E)**

The optional SMA connector can be used to hook up a Spectrum Analyzer for RF evaluation. Note that L4 (1.5nH) must be removed and C141 (15pF) and C37 (150pF) must be installed to activate the connector See (Figure 3).

This is the up-converted spread spectrum output of the card. The center frequency of this signal is 2412-2484MHz depending on the channel of operation. The output power of the signal is approximately +12.5dBm. The peaks of the sidelobes of the output spectrum (i.e., the regrowth) are normally adjusted by the ALC/AGC to be 30dB below the peak of the spectrum per requirements of IEEE 802.11.

The following table delineates the IEEE 802.11 channels and their corresponding center frequencies. Although information contained in Table 1 is deemed to be accurate, local regulatory authorities should be consulted before using such equipment.

**TABLE 1. IEEE 802.11 CHANNELS**

CHANNEL NUMBER	CHANNEL FREQUENCY	GEOGRAPHIC USAGE
1	2412MHz	US, CA, ETSI
2	2417MHz	US, CA, ETSI
3	2422MHz	US, CA, ETSI
4	2427MHz	US, CA, ETSI
5	2432MHz	US, CA, ETSI
6	2437MHz	US, CA, ETSI
7	2442MHz	US, CA, ETSI
8	2447MHz	US, CA, ETSI
9	2452MHz	US, CA, ETSI
10	2457MHz	US, CA, ETSI, FR, SP
11	2462MHz	US, CA, ETSI, FR, SP
12	2467MHz	ETSI, FR
13	2472MHz	ETSI, FR
14	2484MHz	Japan†

**KEY:** US = United States, CA = Canada, ETSI = ETSI countries (except France and Spain), FR = France, SP = Spain.

† In Japan, authorization for Channels 1 through 11 is pending.

**Test Points F and G**

RF local oscillator (LO):

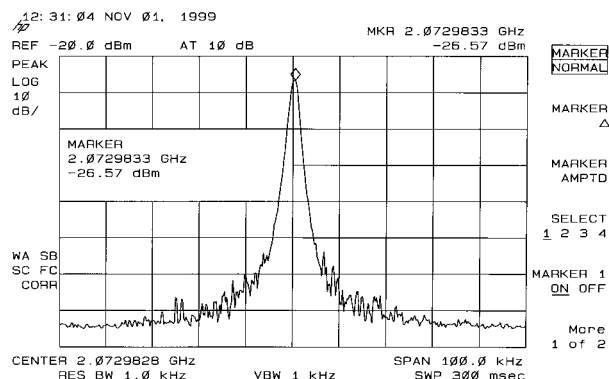

**FIGURE 8. RF LOCAL OSCILLATOR OUTPUT AT CHANNEL 8 (TEST POINT F)**

The behavior of the RF VCO can be monitored at Test Point F.

The VCO output should be locked at the channel frequency minus the IF (374MHz.) This means that the VCO will have to lock between 2038MHz and 2110MHz. The output power at test point F is approximately -6dBm. Ideally, the tuning voltage of the VCO, when locked, falls between 0.5V and 2.2V. The tuning voltage of the RF VCO can be observed at Test Point G.

**Test Points H and I**

IF local oscillator (LO):

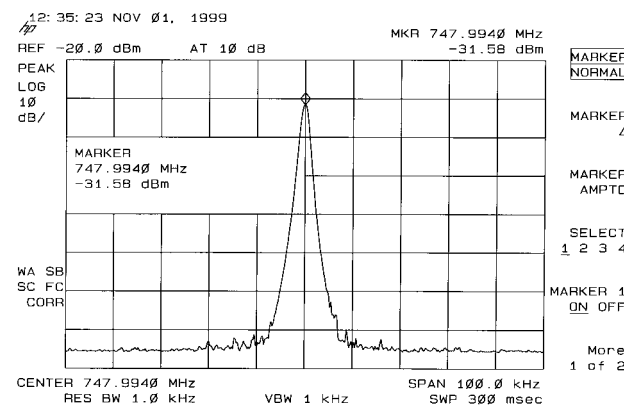

**FIGURE 9. IF LOCAL OSCILLATOR OUTPUT (TEST POINT H)**

The IF VCO is a discrete design and operates at 748MHz (i.e., twice the IF frequency). The output frequency of this VCO does not need to be varied; thus, minimal tuning range is required.

The output frequency of this VCO can be observed at Test Point H.

Ideally, the tuning voltage of the IF VCO, when locked, falls between 0.5V and 2.2V. The tuning voltage of the IF VCO can be observed at Test Point I.



**Test Point J**

IF Receive Signal:

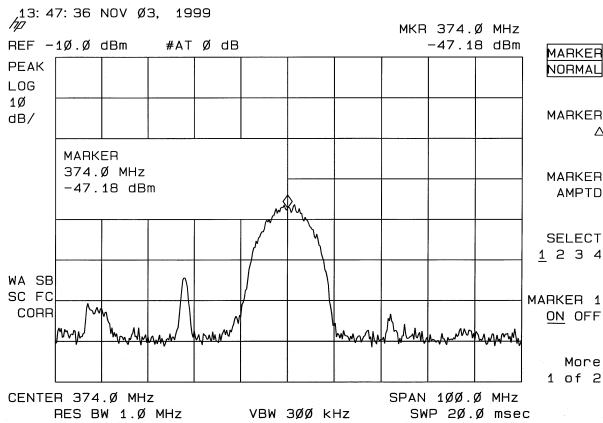

**FIGURE 10. IF RECEIVE SIGNAL PRIOR TO SAW FILTER (TEST POINT J)**

The intermediate frequency (IF) receive signal is the down-converted receive signal prior to the SAW bandpass filter. The center frequency of this signal is 374MHz with a bandwidth of 17MHz. The power of this signal is directly dependent on the input signal power.

Note that the spurious signal visible below the DS spectrum's frequency is a harmonic of the 44MHz clock. Much of this level is due to stray pickup in the 500Ω RF probe because of the relatively low signal level present. As such, it will have no influence on receiver performance.

**Test Point K-K1 and L-L1**

Receive I and Q:

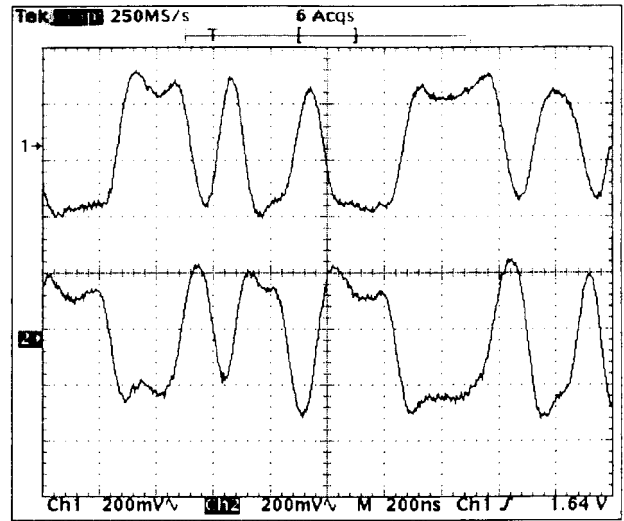
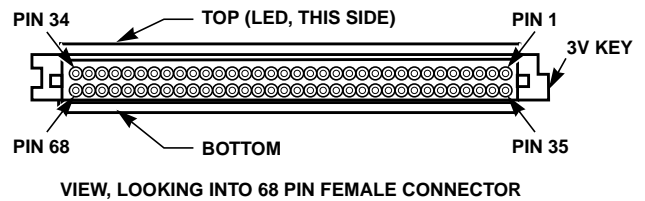

**FIGURE 11. RECEIVE I AND Q SIGNALS (TEST POINTS K AND L)**

NOTE: BPSK mode is used for the plots in this figure; as such, I and Q are inverse of each other.

The receive In-phase and Quadrature (I and Q) signals are the demodulated lowpass-filtered data that are coupled to the HFA3861. The output levels of these two signals are approximately 500mV<sub>p-p</sub>. As these are balanced signals, data is taken using a Tektronix P6247 Differential Probe.

- Test point K for RXI+ signal is at the 0Ω jumper, R19.
- Test point K1 for RXI- signal is at the 0Ω jumper, R23
- Test point L for RXQ+ signal is at the 0Ω jumper, R27
- Test point L1 for RXQ- signal is at the 0Ω jumper, R29.



**FIGURE 12. EDGE VIEW, PCMCIA CARD**

# Application Note 9864

## Absolute Maximum Ratings

Supply Voltage . . . . . -0.3V to 4.0V (Max)  
Storage Temperature (Note 1) . . . . . -20°C to 65°C

## Operating Conditions

Temperature Range . . . . .  $0^{\circ}\text{C} \leq T_A \leq 55^{\circ}\text{C}$   
Supply Voltage Range . . . . . 3.0V to 3.6V

Caution: These are the absolute maximum ratings for the PC Card product. Exceeding these limits could cause permanent damage to the card.

### NOTE:

1. All temperature references refer to ambient conditions.

## Operational Characteristics

See the HWB3163-EVAL data sheet, Intersil File #4794, for more detailed specifications.

TABLE 2. GENERAL SPECIFICATIONS

SPECIFICATION	VALUE
Targeted Standard	IEEE 802.11
Data Rate	1Mbps DBPSK 2Mbps DQPSK 5.5Mbps CCK 11Mbps CCK
Range (11Mbps Data Rate)	120ft (37M) Indoor (Typ) 400ft (122M) Outdoor (Typ)
Center Frequency Range	2412MHz - 2484MHz
Step Size	1MHz
IF Frequency	374MHz
IF Bandwidth	17MHz
RX/TX Switching Speed	2 $\mu$ s (Typ)
Average Current without Power Save 2% Transmit, 98% Receive	187mA (Typ)
Average Current with Power Save 2% TX, 8% RX, 90% Standby	43mA (Typ)
Current in Continuous TX mode	300mA (Typ)
Current in Continuous RX mode	185mA (Typ)
Standby Current	25mA (Typ)
Mechanical	Type II PC Card, with Antenna Extension
Output Power	+11.5dBm (Typ)
Transmit Spectral Mask	-30dBc at First Side Lobes
Antenna Interface	SMA, 50 $\Omega$ (for testing only) Dual Diversity Printed Antenna

## References

For Intersil documents available on the internet, see web site [www.intersil.com/](http://www.intersil.com/)

Intersil AnswerFAX (321) 724-7800.

- [1] *HWB3163-EVAL Data Sheet*, Intersil Corporation, AnswerFAX Doc. No. 4794.
- [2] *AN9850 Application Note*, Intersil Corporation, "Complementary Code Keying Made Simple", AnswerFAX Doc. No. 99850.

## Notices

### Electronic Emission Notices

This device complies with Part 15 of the FCC rules. Operation is subject to the following two conditions:

1. This device may not cause harmful interference.
2. This device must accept any interference received, including interference that may cause undesired operation.

### FCC Radio Frequency Interference Statement

The wireless LAN PC card is subject to the rules of the Federal Communications Commission (FCC). This card is considered an intentional radiator as per the FCC guidelines.

NOTE: This equipment has been tested and found to comply with the limits for a Class B digital device, pursuant to Part 15 of the FCC rules. These limits are designed to provide reasonable protection against harmful interference in a residential installation. This equipment generates, uses and can radiate radio frequency energy and, if not installed and used in accordance with the instruction manual, may cause harmful interference to radio communications. However, there is no guarantee that interference will not occur in a particular installation. If this equipment does cause harmful interference to radio or television reception, which can be determined by turning the equipment off and on, the user is encouraged to try to correct the interference by one or more of the following measures:

- Reorient or relocate the receiving antenna
- Increase the separation between the equipment and the receiver
- Connect the equipment into an outlet on a circuit different from that to which the receiver is connected
- Consult the dealer or an experienced radio/TV technician for help

**WARNING!** Any changes or modifications of equipment not expressly approved by Intersil could void the user's authority to operate the equipment.

All Intersil semiconductor products are manufactured, assembled and tested under **ISO9000** quality systems certification.

*Intersil semiconductor products are sold by description only. Intersil Corporation reserves the right to make changes in circuit design and/or specifications at any time without notice. Accordingly, the reader is cautioned to verify that data sheets are current before placing orders. Information furnished by Intersil is believed to be accurate and reliable. However, no responsibility is assumed by Intersil or its subsidiaries for its use; nor for any infringements of patents or other rights of third parties which may result from its use. No license is granted by implication or otherwise under any patent or patent rights of Intersil or its subsidiaries.*

For information regarding Intersil Corporation and its products, see web site **www.intersil.com**

### **Sales Office Headquarters**

#### **NORTH AMERICA**

Intersil Corporation  
P. O. Box 883, Mail Stop 53-204  
Melbourne, FL 32902  
TEL: (321) 724-7000  
FAX: (321) 724-7240

#### **EUROPE**

Intersil SA  
Mercure Center  
100, Rue de la Fusee  
1130 Brussels, Belgium  
TEL: (32) 2.724.2111  
FAX: (32) 2.724.22.05

#### **ASIA**

Intersil Ltd.  
8F-2, 96, Sec. 1, Chien-kuo North,  
Taipei, Taiwan 104  
Republic of China  
TEL: 886-2-2515-8508  
FAX: 886-2-2515-8369