

Cat. No. 21-1702  
**OWNER'S MANUAL**

Please read before using this equipment.

# TRC-502

## 40-Channel Mini Mobile CB Radio

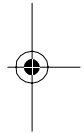
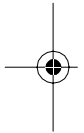

**RadioShack®**

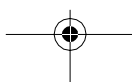

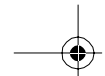

## FEATURES

---

Your RadioShack TRC-502 40-Channel Mini Mobile CB Radio is a great way to communicate with other CB radio operators. Because of its convenient compact size, you can use it just about anywhere. You can mount it in a vehicle for mobile use, or in your home or office for use as a base station.

Your CB has these advanced features.

**Up/Down Channel Selector** — lets you easily select a channel with the press of a button.

**TX (Transmit) Indicator** — lights to show when the CB is transmitting.

**Automatic Noise Limiter (ANL) Circuit** — reduces impulse-type noise during reception.

**5-Pin Din Mic Connector** — uses five prongs to reinforce a clear connection between the mic and the receiver.

**Full Legal Power** — gives you the full range of CB channels with the maximum allowed transmit power.

**Adjustable Squelch** — helps to eliminate noise between transmissions.

**Automatic Modulation** — prevents the transmitter signal from over-modulating and distorting.

**(PLL) Frequency Synthesizer** — provides highly accurate and stable tuning.

**Crystal-Controlled Digital Tuning** — provides precise transmission tuning capability when selecting a channel.

**Two Ceramic Filters** — provide superior channel selectivity and prevent adjacent channel interference.

**Universal Mounting Bracket** — lets you mount your CB securely in your vehicle, or on a table or shelf in your home or office.

**External Antenna Jack** — lets you attach an optional antenna to your CB radio for increased range.

We recommend you record your CB's serial number here. The number is on the bottom of the CB.

Serial Number: \_\_\_\_\_

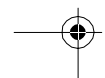
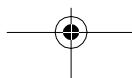



---

## FCC INFORMATION

The Federal Communications Commission (FCC) does not require you to have a license to operate this CB radio. However, you must know Part 95 of *FCC Rules*. These rules apply to the operation of a Class D CB. We have provided a copy of these regulations with your CB radio.

**Warning:** Do not open your CB radio to make any internal adjustments. A CB radio is set up to transmit a regulated signal on an assigned frequency. It is against the law to alter or adjust the settings inside the unit to exceed these limitations.

To be safe and sure:

- never open your CB radio's cases.
- never change or replace anything in your CB radio.

Your CB radio might cause TV or radio interference even when it is operating properly. To determine whether your CB radio is causing the interference, turn off your CB radio. If the interference goes away, your CB is causing it. Try to eliminate the interference by:

- moving your CB radio away from the TV or radio
- contacting your local RadioShack store for help

If you can not eliminate the interference, the FCC requires that you stop using your CB radio.

This device complies with Part 95 of *FCC Rules*. Operation is subject to the following two conditions: 1) this device may not cause harmful interference, and 2) this device must accept any interference received, including interference that may cause undesired operation.



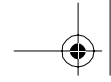

# CONTENTS

---

<b>Installation .....</b>	<b>5</b>
Mounting the Microphone Holder .....	5
Mounting the CB .....	5
Connecting an Antenna .....	6
Connecting the Microphone .....	7
Using Vehicle Battery Power .....	8
Using the CB as a Base Station .....	8
<b>Operation .....</b>	<b>10</b>
Receiving Transmissions and Adjusting Squelch .....	10
Transmitting .....	11
<b>Operational Hints .....</b>	<b>12</b>
Common Uses for a CB .....	12
Personal Uses .....	12
Business Uses .....	12
Transmission Courtesy .....	12
Using Common 10-Codes .....	13
Maximum Range .....	14
Reducing Noise .....	14
<b>Troubleshooting .....</b>	<b>15</b>
<b>Care and Maintenance .....</b>	<b>16</b>
Replacing the Fuse .....	17
<b>Specifications .....</b>	<b>18</b>

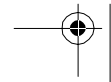
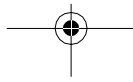

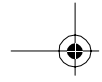

## INSTALLATION

### MOUNTING THE MICROPHONE HOLDER

You can mount the microphone holder to either side of the CB or to another location near your receiver.

**Caution:** Do not mount the CB microphone holder where it could damage or interfere with the operation of any passive restraint safety device (an airbag or seat belt).

To mount the holder to either side of the CB, use the two supplied 1/8-inch (3-mm) machine screws, plain washers, and spring washers as shown to secure the holder.

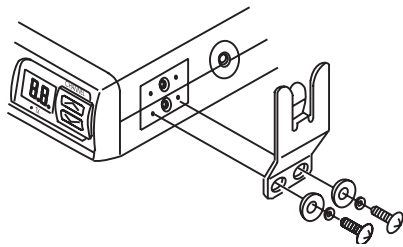

To mount the holder near the receiver in another location in your vehicle (such as a dashboard), or somewhere in your home or office, such as a nearby wall, follow these steps.

1. Using the holder as a template, mark the positions for the screw holes at the desired location.
2. At each marked position, drill a hole slightly smaller than the mounting screws.

**Caution:** Be careful not to drill into anything behind the mounting surface.

3. Mount the holder using the machine screws, spring washers, plain washers and nuts.

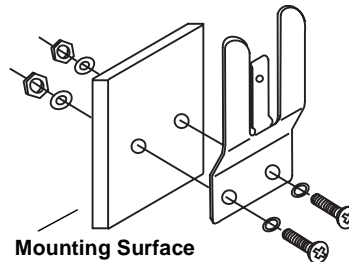

**Note:** If you cannot reach behind the mounting surface to attach the nuts to the machine screws, use the two supplied 1/8-inch (3-mm) screws and plain washers.

### MOUNTING THE CB

The most common mounting location for this CB is under a vehicle's dashboard. However, if you use the TRC-502 as a base station in your home or office, you can place it on a desk, shelf, or table (see "Using the CB as a Base Station" on Page 8).

If you are mounting the CB in a vehicle, choose a location where:

- you can easily reach the CB.
- wires and cables are clear of the vehicle's pedals and other moving parts.



- the CB is not directly in front of heating vents.
- all wires and cables can reach their connection point.

**Cautions:**

- If you use the CB in a vehicle, mount it securely to avoid damage to the CB or vehicle or injury to passengers.
- Do not mount the CB where it could damage or interfere with the operation of any passive restraint safety device (an airbag or seatbelt).

Follow these steps to mount the CB using the supplied hardware.

1. Using the mounting bracket as a template, mark the positions for the screw holes on the mounting surface.

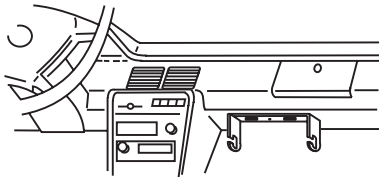

2. In each marked location, drill a hole slightly smaller than the two 1/5-inch (5-mm) mounting screws.

**Caution:** Be careful not to drill into objects behind the mounting surface.

3. Mount the bracket to the mounting surface with the 1/5-inch (5-mm) mounting screws, spring washers, plain washers, and nuts.

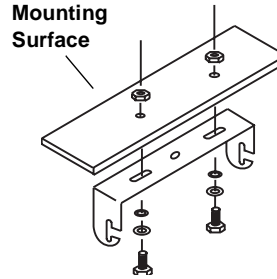

**Note:** If you cannot reach behind the mounting surface to attach the nuts on the bolts, use the 1/5-inch (5-mm) mounting screws and plain washers to secure the bracket.

4. Attach the CB to the mounting bracket using the two rubber washers and mounting knobs.

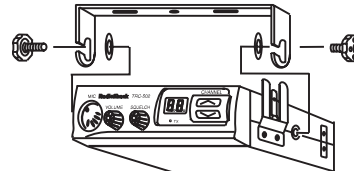

## CONNECTING AN ANTENNA

There are many different types of antennas for mobile CBs, each with its own benefits. You can choose one that best fits your needs. Your local RadioShack store sells a wide variety of antennas.

**Note:** If you are using this CB as a base station, see "Using the CB as a Base Station" on Page 8.

When you choose an antenna, keep in mind that, for the best performance, you should mount the antenna:

- as high as possible on your vehicle, home or building
- as far as possible from source of electrical noise
- vertically

Once you choose an antenna, follow its mounting instructions. Then route the cable to the CB and connect the cable to **ANTENNA** on the back of the CB.

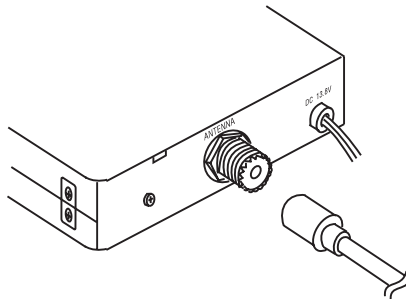

**Cautions:**

- Avoid routing the cable next to sharp edges or moving parts which might damage the cable.
- Do not run the cable next to power cables or other radio antenna cables.
- Do not run the cable through a vehicle's engine compartment or other areas that produce extreme heat.

To take advantage of your radio's maximum range, adjust the antenna's Standing Wave Ratio (SWR) using an SWR meter (such as Cat. No. 21-523).

Follow the instructions supplied with the SWR meter and antenna to adjust your antenna's SWR to the lowest possible value. SWR values of 2.0:1 are generally acceptable, with readings of 1.5:1 or lower being more desirable.

**CONNECTING THE MICROPHONE**

1. Press the plastic tab on the top of the supplied microphone's plug and align the 5-pin DIN microphone plug with the corresponding pin holes in the CB's **MIC** jack. Then push the plug into the mic jack.

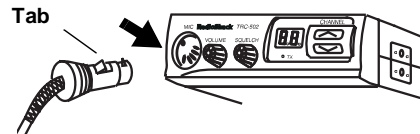

2. Slide the microphone onto the microphone holder.

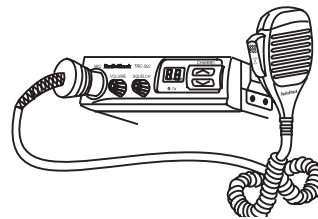

To disconnect the microphone from the CB, press the plastic tab on the side of the plug, then pull out the plug.

**Caution:** Never pull on the microphone cable.

## USING VEHICLE BATTERY POWER

Follow these steps to connect the CB to vehicle battery power.

1. Connect the red wire (with in line fuse holder) to a point in your vehicle's fuse block that has power only when the ignition is in the ACC or ON position.

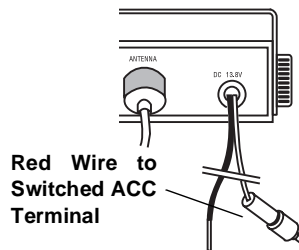

2. Connect the black wire to a metal part of the vehicle's frame (chassis ground).

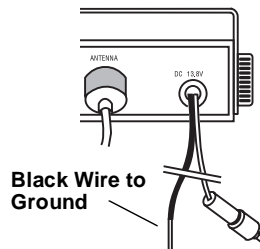

**Caution:** Do not connect the black wire to a non-metallic (plastic) part, or to any part insulated from the vehicle's chassis by a non-metallic part.

## USING THE CB AS A BASE STATION

Although this CB radio is designed mainly for mobile use, you can also use it as a base station with an AC power source. For base station installation, you need these items:

- a 13.8V DC power supply that can supply at least 1.5 amps (such as Cat. No. 22-504)

**Caution:** Most 13.8V DC power supplies plug into a standard AC outlet to produce DC power. Before connecting your CB to a 13.8V DC power supply, read and follow the instructions included with the power supply.

- base station antenna (such as Cat. No. 21-969)
- coaxial antenna cable and connector (available at your local RadioShack store)

**Warning:** Use extreme caution when you install or remove a base station CB antenna. If the antenna starts to fall, let it go! It could contact overhead power lines. If the antenna touches the power line, contact with the antenna, mast, cable or guy wires can cause electrocution and death. Call the power company to remove the antenna. Do not attempt to remove it yourself!



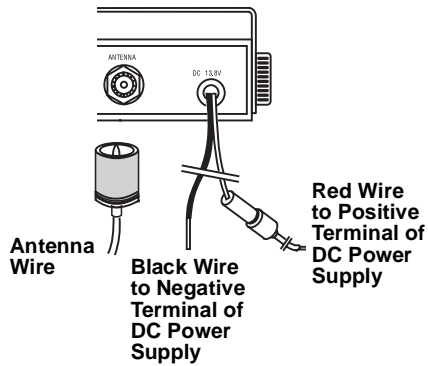

1. Mount the base station antenna as described in its owner's manual.
2. Connect the antenna to **ANTENNA**.
3. Connect the CB's black power wire to the negative (-) terminal on the DC power supply.
4. Connect the CB's red wire to the positive (+) terminal on the DC power supply.
5. Connect the DC power supply to a standard AC outlet.

**Caution:** To prevent damage to the CB, be sure you connect an antenna and the microphone before you use the CB.

## OPERATION

Before you use your CB, you should know how to use it effectively and courteously. "Operational Hints" on Page 12 contains information that will help you get more enjoyment from our CB.

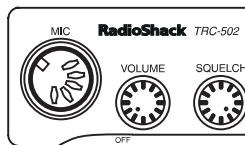

### RECEIVING TRANSMISSIONS AND ADJUSTING SQUELCH

1. Turn **SQUELCH** fully counterclockwise.

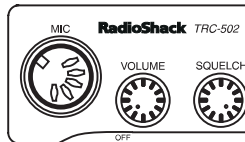

2. Turn on the CB by turning **VOLUME** clockwise until it clicks. The channel display lights and the channel number appears.



3. Press  or  on the base to select the desired channel.

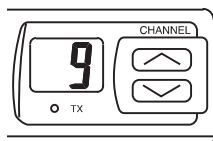

4. Adjust **VOLUME** to a comfortable listening level.
5. To cut out background noise between transmissions, wait until there is no signal, then slowly turn **SQUELCH** clockwise until the background noise stops.

**Note:** To receive very weak signals, turn **SQUELCH** counterclockwise. You hear noise between transmissions, but you also hear weak transmissions.

6. To turn off the CB, turn **VOLUME** counterclockwise until you hear it click. The channel display turns off.

---

## TRANSMITTING

**Note:** We recommend you try receiving before you transmit.

1. Follow Steps 1–5 in “Receiving Transmissions and Adjusting Squelch” on Page 10.
2. To transmit, press **PUSH TO TALK** on the microphone. The red TX indicator lights. Hold the microphone 2–3 inches from your mouth and speak in a normal tone of voice.

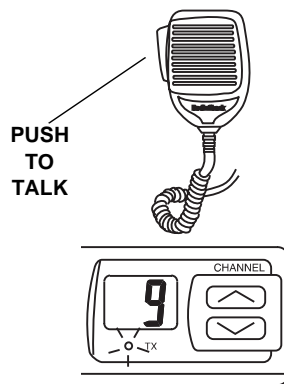

3. To turn off the CB, turn **VOLUME** counterclockwise until you hear it click. The channel display turns off.



## OPERATIONAL HINTS

---

Like most activities, CB radio has its customs and courtesies. The following tips will help you get the most enjoyment from your CB.

### COMMON USES FOR A CB

#### Personal Uses

- Keep in touch with home while driving to work, to the store, or to a social activity. Let your family know you are tied up in traffic or that you will stop by the store on the way home.
- If you are a two-car (or more) family, CB radios are great for communicating with family members while they are in their cars.
- Contact friends or neighbors — find out “what’s happening” or plan a get-together.
- Ever have car trouble or run out of gas on the highway? What an assurance it is to be able to radio for assistance!
- Camping, fishing, and other sports are more fun with a CB radio. Locate a buddy or find out “what’s cooking” back at camp.

#### Business Uses

- For security officers, a CB is more than a convenience — it is a must for both safety and efficiency.
- Truck drivers and delivery personnel can learn road and traffic conditions and get assistance in locating destinations. A CB radio is also good company on those “long hauls.”
- On construction crews, a CB radio quickly pays for itself when you are calling for additional materials or coordinating the activities of different work crews.

### TRANSMISSION COURTESY

Please follow these guidelines of radio courtesy when using your CB.

- Wait for a pause in someone else’s transmission before you ask for a break.
- If you do not receive an answer to your call after a second attempt, sign off and wait several minutes before trying again.
- Do not hold down **PUSH TO TALK** when you are not talking. (This is called *dead keying*.)
- Assist callers with directions, information about road conditions, and any other reasonable requests.

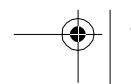
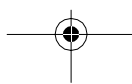

## USING COMMON 10-CODES

Citizen's band operators and CB radio users have largely adopted the 10-codes for standard questions and answers. These codes permit faster communication and better intelligibility in noisy areas.

This table lists codes adopted by the Associated Public Safety Communications Officers (APCO).

Code	Meaning
10-1	Your signal is bad.
10-2	Your signal is good.
10-3	Stop transmitting.
10-4	Message received and understood.
10-5	Relay information to _____.
10-6	I am busy or are you busy?
10-7	Out of service.
10-8	In service.
10-9	Repeat last message.
10-10	Negative (NO).
10-11	_____ in service.
10-12	Stand by.
10-13	Report road/weather conditions.
10-14	Information.
10-15	Message delivered.

Code	Meaning
10-16	Reply to message.
10-17	En route.
10-18	Urgent.
10-19	Contact _____.
10-20	What is your location?
10-21	Call _____ by telephone.
10-22	Cancel last message.
10-23	Arrived at the scene.
10-24	Assignment complete.
10-25	Meet _____.
10-26	Estimated time of arrival is _____.
10-30	Use caution.
10-31	Pick up.
10-33	Emergency traffic. Clear the channel.
10-34	What time is it?
10-41	Switch to Channel xx.
10-62	Cannot understand.

**Note:** Although this table lists the 10-codes' meanings in the form of a statement, they can also be phrased as questions (10-6: Are you busy?, 10-20: What is your location?).

## MAXIMUM RANGE

The maximum range and quality of CB radio transmissions vary depending on the following conditions:

- the type and quality of antenna used
- the height of the antenna's mounting location — the higher the antenna, the better the signal's range
- the surrounding terrain — mountains and tall buildings limit the range
- weather conditions
- the number of nearby radios operating on the same channel
- standing wave ratio (SWR) between the antenna and the CB

**Note:** Your CB radio's transmission range is generally line-of-sight.

## REDUCING NOISE

Because your CB is exceptionally quiet, any noise you hear is probably from an external source in your vehicle such as an alternator, another radio or spark plugs.

The transceiver uses an ANL (Automatic Noise Limiter) circuit to reduce noise. However, if possible, try to eliminate the noise by finding its source.

You can determine the noise's source by turning off the engine and operating the CB with your vehicle's ignition set to ACC (or ON). If the noise is reduced, the problem is in your vehicle's ignition or electrical system.

Here are a few hints to help you reduce or eliminate such noise.

- Make all CB power and antenna wires as short as possible.
- Route the power wires away from the antenna wires.
- Be sure that the chassis ground connection is secure.
- Replace old ignition wires with new, high-voltage, noise suppression wires.
- Install noise suppressors on your spark plugs, or install new spark plugs that have built-in noise suppressors.
- If problems persist, check your alternator/generator and regulator gauges. You can reduce the noise from these sources by using bypass capacitors at the various output voltage points.

Your local RadioShack store has a wide selection of noise suppression accessories.

## **TROUBLESHOOTING**

If your CB is not working as it should, follow these suggestions to see if you can eliminate the problem. If you cannot, take the CB to your local RadioShack store for assistance.

<b>Symptom</b>	<b>Check/Try</b>
CB has trouble receiving.	Turn CB power on.
	Microphone connected? Secure connections.
	Antenna connected? Secure connections.
	Too much squelch? Adjust as needed.
	Radio not on an operating channel? Switch to an active channel.
	Adjust <b>VOLUME</b> .
CB has trouble transmitting.	Turn power on.
	Antenna connected? Secure connections.
	All connections free of corrosion? Clean and tighten.
	Microphone connector loose? Firmly press connector into MIC jack.
	Radio not on an operating channel? Switch to an active channel.
	<b>PUSH TO TALK</b> fully pressed? Press completely.
Radio does not work at all.	Power connected? Secure connections.
	Microphone connected? Secure connections.
	Antenna connected? Secure connections.
	Fuse needs replacing? Replace with identical fuse. See "Replacing the Fuse" on Page 17.
Cannot select a channel.	<b>PUSH TO TALK</b> pressed? Release <b>PUSH TO TALK</b> .

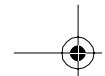

## CARE AND MAINTENANCE

---

Your RadioShack TRC-502 40-Channel Mini Mobile CB Radio is an example of superior design and craftsmanship. The following suggestions will help you care for your CB so you can enjoy it for years.



Keep the CB dry. If it gets wet, wipe it dry immediately. Liquids might contain minerals that can corrode the electronic circuits.



Use and store the CB only in normal temperature environments. Temperature extremes can shorten the life of electronic devices, and distort or melt plastic parts.



Keep the CB away from dust and dirt, which can cause premature wear of parts.



Handle the CB gently and carefully. Dropping it can damage circuit boards and cases and can cause the CB to work improperly.



Wipe the CB with a damp cloth occasionally to keep it looking new. Do not use harsh chemicals, cleaning solvents, or strong detergents to clean the CB.

Modifying or tampering with the CB's internal components can cause a malfunction and invalidate its warranty and void your FCC authorization to operate it. If your CB is not performing as it should, take it to your local RadioShack store for assistance.



---

## REPLACING THE FUSE

The TRC-502's 2-amp in-line fuse helps protect your CB from power surges and short circuits. When replacement is required, use a 2-amp, slow-blow glass fuse, such as Cat. No. 270-1023.

**Caution:** Do not use a fuse with ratings other than those specified here. Doing so might damage your CB.

Follow these steps to replace the fuse.

1. Make sure the power source and CB are both off.
2. Hold the fuse holder by both ends, push the ends together, twist one end counterclockwise, then pull them apart.

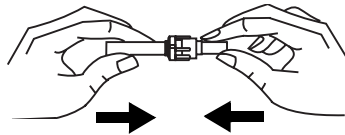

3. Remove the old fuse and inspect its condition. If it is not blown, reinsert it. If it is blown, insert a new one of the same type and rating.
4. Push the fuse holder ends together and twist one end clockwise.

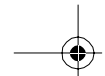

# SPECIFICATIONS

## RECEIVER

Frequency Coverage ..... All 40 Channels (Class D) 26.965 to 27.405 MHz  
 Sensitivity ..... 0.5 uV or Better for 10 dB S/N  
 Squelch Sensitivity ..... From 0.5 uV to 1 mV Adjustable (Nominal)  
 Frequency Response ..... - 6 dB 450 Hz to 2.5 kHz  
 Adjacent Channel Selectivity ..... 45 dB at 10 kHz Away  
 Audio Output Power ..... 1 Watt  
 Cross Modulation ..... 50 dB

## TRANSMITTER

Frequency Coverage ..... All 40 Channels (Class D) 26.965 to 27.405 MHz  
 Frequency Tolerance ..... +/- 100 Hz (Nominal)  
 Output Power ..... 3.7 Watts (Nominal)  
 Modulation Type ..... A3  
 Antenna Impedance ..... 50 Ohm  
 Spurious Emission ..... - 67 dB or Better  
 Modulation Capability ..... 90%  
 Current Drain ..... 1.1 Amps with no modulation; 1.5 Amps with 80% modulation  
 Power Requirements ..... 13.8 V DC, Negative Ground

## GENERAL

Dimensions ..... 6 <sup>6</sup>/<sub>8</sub> ¥ 4 <sup>2</sup>/<sub>8</sub> ¥ 1 <sup>3</sup>/<sub>8</sub> Inches (171 ¥ 108 ¥ 35 mm)  
 Weight (with microphone) ..... 21 Oz. (595 g)

Specifications are typical, individual units might vary. Specifications are subject to change and improvement without notice.



# NOTES

---

---

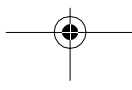
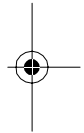
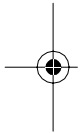

### Limited Ninety-Day Warranty

This product is warranted by RadioShack against manufacturing defects in material and workmanship under normal use for ninety (90) days from the date of purchase from RadioShack company-owned stores and authorized RadioShack franchisees and dealers. EXCEPT AS PROVIDED HEREIN, RadioShack MAKES NO EXPRESS WARRANTIES AND ANY IMPLIED WARRANTIES, INCLUDING THOSE OF MERCHANTABILITY AND FITNESS FOR A PARTICULAR PURPOSE, ARE LIMITED IN DURATION TO THE DURATION OF THE WRITTEN LIMITED WARRANTIES CONTAINED HEREIN. EXCEPT AS PROVIDED HEREIN, RadioShack SHALL HAVE NO LIABILITY OR RESPONSIBILITY TO CUSTOMER OR ANY OTHER PERSON OR ENTITY WITH RESPECT TO ANY LIABILITY, LOSS OR DAMAGE CAUSED DIRECTLY OR INDIRECTLY BY USE OR PERFORMANCE OF THE PRODUCT OR ARISING OUT OF ANY BREACH OF THIS WARRANTY, INCLUDING, BUT NOT LIMITED TO, ANY DAMAGES RESULTING FROM INCONVENIENCE, LOSS OF TIME, DATA, PROPERTY, REVENUE, OR PROFIT OR ANY INDIRECT, SPECIAL, INCIDENTAL, OR CONSEQUENTIAL DAMAGES, EVEN IF RadioShack HAS BEEN ADVISED OF THE POSSIBILITY OF SUCH DAMAGES.

Some states do not allow the limitations on how long an implied warranty lasts or the exclusion of incidental or consequential damages, so the above limitations or exclusions may not apply to you.

In the event of a product defect during the warranty period, take the product and the RadioShack sales receipt as proof of purchase date to any RadioShack store. RadioShack will, at its option, unless otherwise provided by law: (a) correct the defect by product repair without charge for parts and labor; (b) replace the product with one of the same or similar design; or (c) refund the purchase price. All replaced parts and products, and products on which a refund is made, become the property of RadioShack. New or reconditioned parts and products may be used in the performance of warranty service. Repaired or replaced parts and products are warranted for the remainder of the original warranty period. You will be charged for repair or replacement of the product made after the expiration of the warranty period.

This warranty does not cover: (a) damage or failure caused by or attributable to acts of God, abuse, accident, misuse, improper or abnormal usage, failure to follow instructions, improper installation or maintenance, alteration, lightning or other incidence of excess voltage or current; (b) any repairs other than those provided by a RadioShack Authorized Service Facility; (c) consumables such as fuses or batteries; (d) cosmetic damage; (e) transportation, shipping or insurance costs; or (f) costs of product removal, installation, set-up service adjustment or reinstallation.

This warranty gives you specific legal rights, and you may also have other rights which vary from state to state.

RadioShack Customer Relations, Dept. W, 100 Throckmorton St., Suite 600, Fort Worth, TX 76102

*We Service What We Sell*

3/97

**RadioShack**  
**A Division of Tandy Corporation**  
**Fort Worth, Texas 76102**

811081350B  
Printed in China

1A9