



MOTOROLA

XTN SERIES TWO-WAY RADIO

User's Guide



6864110R04-A

Models XU1100, XU2100, XU2600,
XV1100, XV2100, and XV2600

Introduction

Thank you for purchasing a Motorola® **XTN** Series Radio. Your radio is a product of Motorola's 70 plus years of experience as a world leader in the designing and manufacturing of communications equipment. The **XTN** Series radios provide cost-effective communications for businesses such as retail stores, restaurants, schools, construction sites, manufacturing, property and hotel management and more. Motorola professional two-way radios are the perfect communications solution for all of today's fast-paced industries.

Note: Please read this manual carefully to ensure you know how to properly operate the radio before use.

Package Contents

- Radio
- Swivel Belt Holster
- NiMH Battery
- 10-Hour Charger
- User's Guide
- Accessory Brochure
- Warranty Card
- Drop-In Charging Tray (not included with all models)

Motorola, the Stylized M Logo, and all other trademarks indicated as such herein are Trademarks of Motorola, Inc.

®Reg. U.S. Pat. & Tm. Off. © 2001, 2002 Motorola, Inc. All rights reserved.

For a copy of a large-print version of this guide, or for product-related questions, please contact:

1-800-448-6686 in the USA

1-800-461-4575 in Canada

1-888-390-6456 on your TTY (Text Telephone)

On the web, please refer to: www.motorola.com/radios/professional

Contents	
Introduction	1
FCC Licensing Information	5
Safety and General Information ..	7
Getting Started	15
Installing the Swivel Belt	
Holster	16
Installing the Nickel-Metal	
Hydride Battery	17
Charging the XSeries Radio	18
Turning Your Radio On or Off ...	19
Adjusting the Volume	19
Using the Radio	19
Understanding the Display	21
Battery and Charging Options ..	22
NiMH Battery.....	22
Alkaline Batteries	22
Charging with the Drop-in	
Charging Tray	23
Reading the Battery Meter	24
Battery Life.....	24
XTN Series Factory Defaults	25
Talking and Receiving	26
Signal Strength Indicator/Channel	
Busy.....	26
Talk Range.....	26
Keypad Lock.....	27
Hands-Free Use/VOX	27
With Compatible VOX	
Accessories.....	27
Without Accessories	28
Setting VOX Sensitivity	28
Monitoring a Channel	29
Scanning	29
Programming Features	31
Entering Programming Mode	31
Programming a Channel	32
Programming the Frequency.....	32
Programming the Interference	
Eliminator Code.....	33
Assigning Channels	
to Presets	33
Programming the Scramble	
Feature.....	34
Programming Bandwidth	34
Programming the Available	
Channel	35
Programming Call Tones	35
Programming Microphone	
Gain.....	36
Editing the Scan List	36
Cloning	37

Advanced Features	39	Motorola Limited Warranty	53
Troubleshooting	41	Software Copyright Notice	61
Use and Care	44	Patent Notice.....	61
Frequencies and Bandwidths.....	45	Export Law Assurances	62
Verifying the M-Series Frequency		Index	64
and Code Setting.....	51		

FCC Licensing Information

XTN Series professional two-way radios operate on radio frequencies that are regulated by the Federal Communications Commission (FCC). In order to transmit on these frequencies, you are required to have a license issued by the FCC.

Application is made available on FCC Form 601 and Schedules D, H, and Remittance Form 159.

To obtain these FCC forms please request document **000601** which includes all forms and instructions. If you wish to have the document faxed, mailed or have questions, please use the following contact information.

Faxed contact the Fax-On- Demand system at:	Mailed call the FCC forms hotline at:	Questions regarding FCC license contact the FCC at:
1-202-418-0177	1-800-418-FORM 1-800-418-3676	1-888-CALL-FCC 1-888-225-5322 Or: http://www.fcc.gov

Before filling out your application, you must decide which frequency(ies) you can operate on. See Frequencies and Bandwidths.

For questions on determining your radio frequency, please call Motorola Product Services at: 1-800-448-6686.

Changes or modifications not expressly approved by Motorola may void the user's authority granted by the FCC to operate this radio and should not be made. To comply with FCC requirements, transmitter adjustments should be made only by or under the supervision of a person certified as technically qualified to perform transmitter maintenance and repairs in the private land mobile and fixed services as certified by an organization representative of the user of those services. Replacement of any transmitter component (crystal, semiconductor, etc.) not authorized by the FCC equipment authorization for this radio could violate FCC rules.

Note: Use of this radio outside the country where it was intended to be distributed is subject to government regulations and may be prohibited.

Safety and General Information

Important Information on Safe and Efficient Operation

Read This Information Before Using Your Radio

The information provided in this document supersedes the general safety information contained in user guides published prior to July 2000. For information regarding radio use in a hazardous atmosphere please refer to the Factory Mutual (FM) Approval Manual Supplement or Instruction Card, which is included with radio models that offer this capability.

This device complies with Part 15 of the FCC Rules. Operation is subject to the following two conditions: (1) this device may not cause harmful interference, and (2) this device must accept any interference received, including interference that may cause undesired operation.

RF Operational Characteristics

Your radio contains a transmitter and a receiver. When it is ON, it receives and transmits radio frequency (RF) energy. The **XTN** Series VHF radios operate in the frequency range of 151-158 MHz, the **XTN** Series UHF radios operate in the frequency range of 461-469 MHz. When you communicate with XU1100 or XV1100 radios the output power level is 1.0 watt, with other **XTN** Series radios the output power level is 2.0 watts.

Transmit and Receive Procedure

Your two-way radio contains a transmitter and a receiver. To transmit (talk), you must push the Push-to-Talk button; to receive (listen), release the Push-to-Talk button.

Exposure to Radio Frequency Energy

Your Motorola radio is designed to comply with the following national and international standards and guidelines regarding exposure of human beings to radio frequency electromagnetic energy:

- United States Federal Communications Commission, Code of Federal Regulations; 47 CFR part 2 sub-part J
- American National Standards Institute (ANSI) / Institute of Electrical and Electronic Engineers (IEEE) C95. 1-1992
- Institute of Electrical and Electronic Engineers (IEEE) C95.1-1999 Edition
- National Council on Radiation Protection and Measurements (NCRP) of the United States, Report 86, 1986
- International Commission on Non-Ionizing Radiation Protection (ICNIRP) 1998
- Ministry of Health (Canada) Safety Code 6. Limits of Human Exposure to Radio Frequency Electromagnetic Fields in the Frequency Range from 3 kHz to 300 GHz, 1999
- Australian Communications Authority Radiocommunications (Electromagnetic Radiation - Human Exposure) Standard 1999 (applicable to wireless phones only)

To assure optimal radio performance and make sure human exposure to radio frequency electromagnetic energy is within the guidelines set forth in the above standards, always adhere to the following procedures:

Portable Radio Operation and EME Exposure

Antenna Care

Use only the supplied or an approved replacement antenna. Unauthorized antennas, modifications, or attachments could damage the radio and may violate FCC regulations.

DO NOT hold the antenna when the radio is “IN USE.” Holding the antenna affects the effective range.

Two-Way Radio Operation

When using your radio as a traditional two-way radio, **hold the radio in** a vertical position with the microphone two to three inches (5.0 to 7.5 cm) away from the lips.

Body-Worn Operation

To maintain compliance with FCC/Health Canada RF exposure guidelines, if you wear a radio on your body when transmitting, always place the radio in a **Motorola supplied or approved clip, holder, holster, case, or body harness for this product.** Use of non-Motorola-approved accessories may exceed FCC RF exposure guidelines. **If you do not use a body-worn accessory, ensure the radio and its antenna are at least one inch (2.5 cm) from your body when transmitting.**

Data Operation

When using any data feature of the radio, with or without an accessory cable, position the radio and its antenna at least one inch (2.5 cm) from the body.

Approved Accessories

For a list of approved Motorola accessories refer to the Two-Way Radio section of www.motorola.com/store.

Electromagnetic Interference/Compatibility

Note: Nearly every electronic device is susceptible to electromagnetic interference (EMI) if inadequately shielded, designed or otherwise configured for electromagnetic compatibility.

Facilities

To avoid electromagnetic interference and/or compatibility conflicts, turn off your radio in any facility where posted notices instruct you to do so. Hospitals or health care facilities may be using equipment that is sensitive to external RF energy.

Aircraft

When instructed to do so, turn off your radio when on board an aircraft. Any use of a radio must be in accordance with applicable regulations per airline crew instructions.

Medical Devices

Pacemakers

The Advanced Medical Technology Association recommends that a minimum separation of 6 inches (15 centimeters) be maintained between a handheld wireless radio and a pacemaker. These recommendations are consistent with the independent research by, and recommendations of the U.S. Food and Drug Administration.

Persons with pacemakers should:

- ALWAYS keep the radio more than six inches (15 centimeters) from their pacemaker when the radio is turned ON.
- not carry the radio in the breast pocket.
- use the ear opposite the pacemaker to minimize the potential for interference.
- turn the radio OFF immediately if you have any reason to suspect that interference is taking place.

Hearing Aids

Some digital wireless radios may interfere with some hearing aids. In the event of such interference, you may want to consult your hearing aid manufacturer to discuss alternatives.

Other Medical Devices

If you use any other personal medical device, consult the manufacturer of your device to determine if it is adequately shielded from RF energy. Your physician may be able to assist you in obtaining this information.

Safety and General Use While Driving

Check the laws and regulations on the use of radios in the area where you drive. Always obey them. When using your radio while driving, please:

- Give full attention to driving and to the road.
- Use hands-free operation, if available.
- Pull off the road and park before making or answering a call if driving conditions so require.

Operational Warnings

For Vehicles with an Air Bag

Do not place a portable radio in the area over an air bag or in the air bag deployment area. Air bags inflate with great force. If a portable radio is placed in the air bag deployment area and the air bag inflates, the radio may be propelled with great force and cause serious injury to occupants of the vehicle.

Potentially Explosive Atmospheres

Turn off your radio prior to entering any area with a potentially explosive atmosphere, unless it is a radio type especially qualified for use in such areas as "Intrinsically Safe." Do not remove, install, or charge batteries in such areas. Sparks in a potentially explosive atmosphere can cause an explosion or fire resulting in bodily injury or even death.

Note: The areas with potentially explosive atmospheres referred to above include fueling areas such as below decks on boats, fuel or chemical transfer or storage facilities, areas where the air contains chemicals or particles, such as grain, dust or metal powders, and any other area where you would normally be advised to turn off your vehicle engine. Areas with potentially explosive atmospheres are often but not always posted.

Blasting Caps and Areas

To avoid possible interference with blasting operations, turn off your radio when you are near electrical blasting caps, in a blasting area, or in areas posted: "Turn off two-way radio." Obey all signs and instructions.

Operational Cautions

Antennas

Do not use any portable radio that has a damaged antenna. If a damaged antenna comes into contact with your skin, a minor burn can result.

Batteries

All batteries can cause property damage and/or bodily injury such as burns if a conductive material such as jewelry, keys, or beaded chains touch exposed terminals. The conductive material may complete an electrical circuit (short circuit) and become quite hot. Exercise care in handling any charged battery, particularly when placing it inside a pocket, purse, or other container with metal objects.

Charging Safety Instructions

Before using the battery charger, read all instructions and cautionary markings on:

1. the battery
2. the battery charger, and
3. the radio using the battery.

Caution: To reduce the risk of injury, charge only the rechargeable battery. Other types of batteries may burst, causing personal injury and damage.

Save these Instructions

1. Do not expose the charger to rain or snow.
2. Do not operate the charger if it has received a sharp blow, or has been dropped or damaged in any way.
3. Do not disassemble the charger if it has received a sharp blow, or has been dropped or damaged in any way.

4. Never alter the AC cord or plug provided with the unit. If plug will not fit the outlet, have proper outlet installed by a qualified electrician. An improper condition can result in a risk of electric shock.
5. To reduce risk of damage to cord or plug, pull the plug rather than the cord when disconnecting charger from AC receptacle.
6. To reduce the risk of electric shock, unplug the charger from the outlet before attempting any maintenance or cleaning.
7. Use of an attachment not recommended or sold by Motorola may result in a risk of fire, electric shock, or personal injury.
8. Make sure that the cord is located so that it will not be stepped on, tripped over, or subjected to damage or stress.
9. An extension cord should not be used unless absolutely necessary. Use of an improper extension cord could result in a risk of fire and/or electric shock. If an extension cord must be used, make sure:
 - That the pins on the plug of the extension cord are the same number, size and shape as those on the plug of the charger.
 - That the extension cord is properly wired and in good electrical condition, and
 - That the cord size is 18 AWG for lengths up to 100 feet, and 16 AWG for lengths up to 150 feet.

The supply cord of this charger cannot be replaced. If the cord is damaged, call Motorola Product Services at:

1-800-448-6686 (USA.)
1-800-461-4575 (Canada)
1-888-390-6456 TTY (Text Telephone)

Getting Started

This User's Guide covers several **XTN** Series models, and may detail some features your radio does not have. Your model number is shown on the back of the radio above the battery door, and tells you the following information:

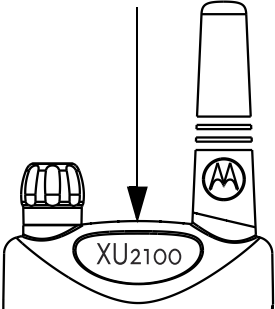
Model	Model Number Location	Frequency Band	Transmit Power (Watts)	Number of Channels
XU1100		UHF	1	1
XU2100		UHF	2	1
XU2600		UHF	2	6
XV1100		VHF	1	1
XV2100		VHF	2	1
XV2600		VHF	2	6

Scan 6-channel models only
 Scramble 2-watt models only

Installing the Swivel Belt Holster

1. Slide the bottom of radio into the holster until it snaps into place.
2. To remove, push the tab above the battery door and pull the radio from holster.

Note: In case of loss, please contact your point-of-sale or call 1-800-448-6686 to request replacement part number NNTN4106AR.



53821 Swivel Belt Holster

Installing the Nickel-Metal Hydride Battery

Your radio is powered by an NiMH battery, which provides up to 15 hours* of usage. Before you install the battery, mark the date in the "INSTALL DATE" section with a permanent marker. As in vehicles, all rechargeable batteries lose capacity over time.

1. Push and hold down the ribbed latch on the bottom of the radio toward the contacts, then slide and lift the battery door off.
2. With the Motorola logo side up, and the charge contacts facing the bottom of the radio, insert the top of the battery into the radio.
3. Push the battery up and into the battery compartment to fit tightly into place.
4. Slide and snap the battery door into place.

*Based upon 5% transmit/ 5% receive/ 90% standby (standard duty cycle).

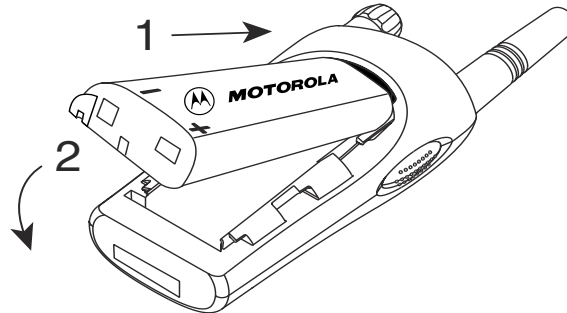
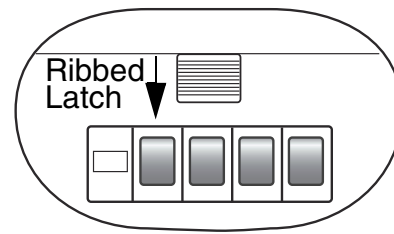

Getting Started

XTN

17

Charging the **XTN** Series Radio

Charge the NiMH battery for 16 hours before using it for the first time. It will only need up to eight hours of charging thereafter.

1. Make sure the radio is off.
2. Lift the accessory cover and plug the 53874 charger (NNTN4077) into the lower jack.
3. Plug the charger into a power outlet. The light on the charger glows during charging.

Note: For optimum battery life, do not charge the battery for prolonged periods after it is fully charged. Charging the battery over the weekend is acceptable.

If the radio is on while charging, additional time is required to charge the battery.

Use only the charger supplied with the radio, or other **XTN** Series power accessories. See "Battery and Charging Options" on page 22.

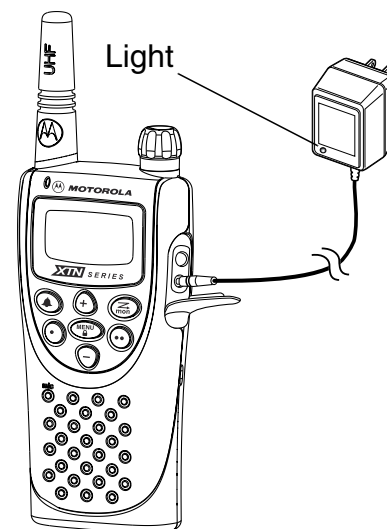

Getting Started

XTN

18

Turning Your Radio On or Off

Turn  clockwise for On or counterclockwise for Off.

The radio chirps and the display briefly shows all features and display segments of your XTN Series radio.

Then the radio displays the current channel (larger number in the center) and the frequency assigned to that channel (on right).

The interference eliminator code displays briefly. Then the current channel remains displayed.

The transmit light on the front left of the radio flashes every three seconds when the radio is on.



Frequency

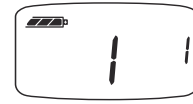



Code

Adjusting the Volume

You can set the volume by turning .

Note: Do not hold the radio too close to your ear when adjusting the volume or if it is at a high setting.

Using the Radio

1. Press and hold  to check for channel activity. If you hear static, the channel is clear to use. Do not transmit if someone is speaking on the channel. Press  again to stop monitoring the channel.
2. Press and hold  and speak into the microphone. To maximize clarity, hold the radio two-to-three inches away from your mouth.

Note: The transmit light on the front left of the radio lights red when transmitting.

3. Release  and listen for messages.

Basic Operation

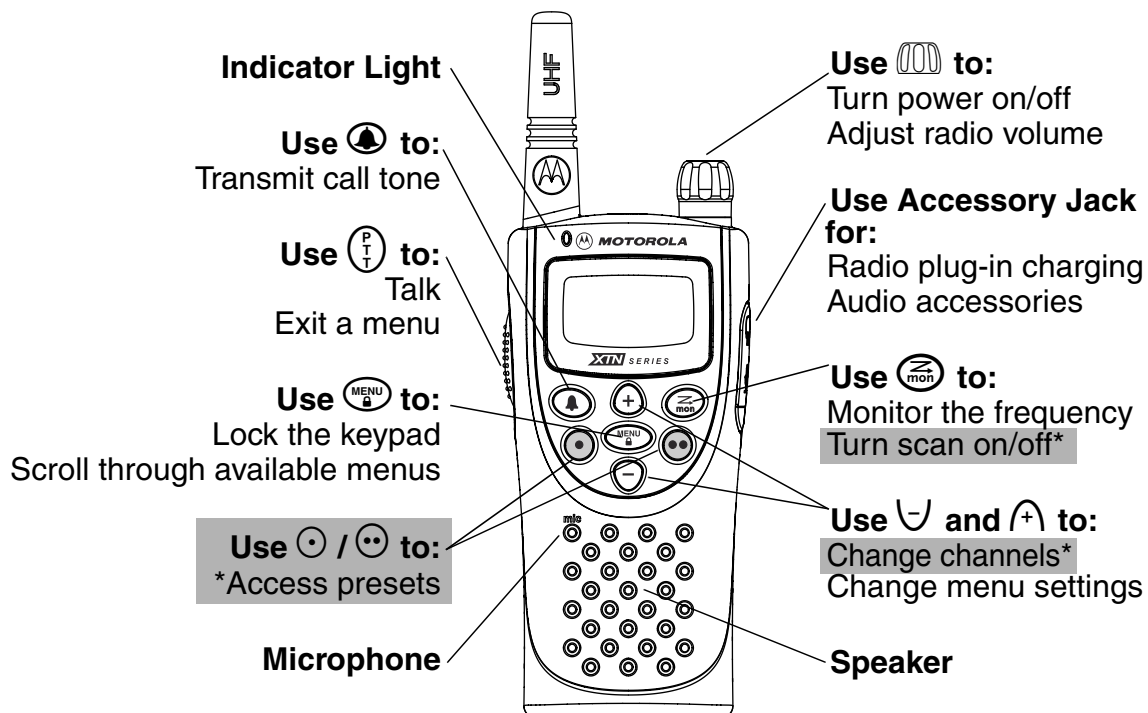

* XU2600 and XV2600 only

Understanding the Display

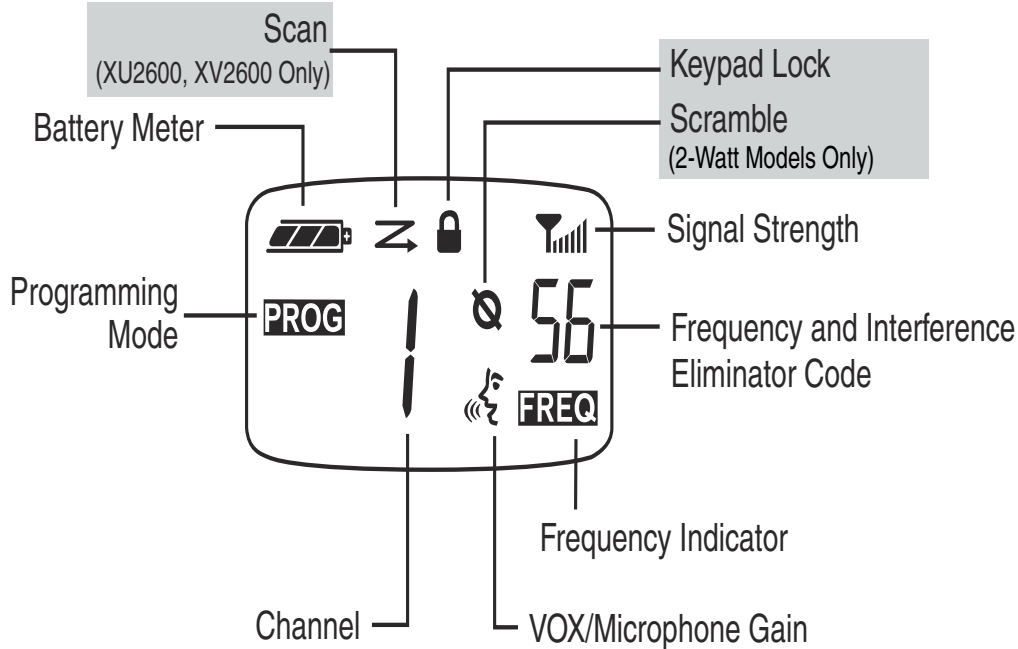

Battery and Charging Options



You have several battery and charging options on your **XTN** Series Two-Way Radio.

NiMH Battery

See "Installing the Nickel-Metal Hydride Battery" on page 17.

Alkaline Batteries

Your radio can also use 4 AA batteries; alkaline cells provide up to 24 hours* of radio use.

1. Push the ribbed latch on the bottom of the radio away from the battery door.
2. Slide and lift the battery door off.
3. Place the AA batteries matching the markings in the compartment.
4. Slide and snap the battery door into place.
5. Press  until **A** or **n** flashes.
6. Press  or  to select **A** for alkaline batteries, or **n** for rechargeable AA cells.

Note: This menu does not appear if the Motorola NiMH Battery is in use.

*Please refer to the diagram and Battery Life on page 24.

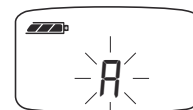
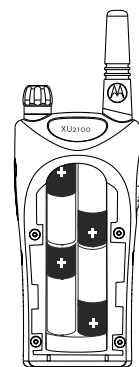

Charging with the Drop-in Charging Tray
(Not included with all models)

1. Place the drop-in charging tray on a flat surface.
2. Insert the plug of the 10-hour charger into the jack of the drop-in charging tray.
3. Plug the charger into a power outlet.

Insert the battery or radio into the tray with the Motorola logo or radio front facing the front of the charger and the contacts facing down.

Note: To extend battery life, do not overcharge. Charging the battery over the weekend is acceptable. If the radio is on while charging, it will take longer to fully charge. Use only the charger supplied with the radio, or other **XTN** Series power accessories.

You can charge only one radio or battery at a time.

Tips: The radio can remain in the holster while charging.

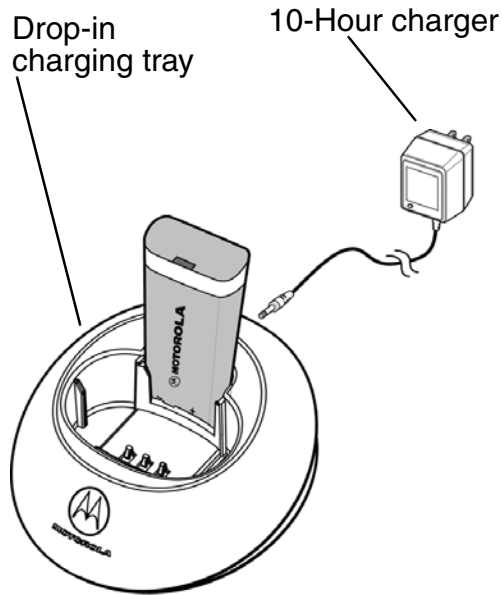

Reading the Battery Meter

The battery meter located in the upper left corner of display indicates how much battery power you have remaining.

Battery Type	3 Bars	2 Bars	1 Bar	Flashing
NiMH	100%-85%	85%-25%	25%-10%	Final 10%
AA Alkaline	100%-75%	75%-40%	40%-10%	Final 10%

Battery Life



Watts	NiMH	Alkaline
2	13 Hours	22 Hours
1	15 Hours	24 Hours

XTN Series Factory Defaults

Your XTN radio is programmed at the factory to the following settings. If you need to change settings, refer to Programming Features on page 31.

Channel	UHF		VHF	
	Frequency	Bandwidth	Frequency	Bandwidth
1	2	25.0	3	25.0
2	8	25.0	4	25.0
3	5	25.0	1	25.0
4	6	25.0	2	25.0
5	10	12.5	10	25.0
6	12	12.5	12	25.0

- Code: On (1)
- Call Tone: Off (0)
- VOX: Off (0)
- Scramble: Off (0)

To restore your radio to factory default programming, turn the radio on while holding the  and  for three seconds.

Talking and Receiving

Signal Strength Indicator/Channel Busy

The radio displays  when activity is on the frequency, and the transmit light flashes at a faster rate of once per second.

When receiving, the display will show  and a signal strength from 1 (weakest) through 5 (strongest). This can help determine when a radio is moving out of range.

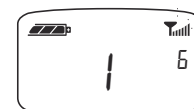



Note: Obstacles that block the signal path may affect the strength of the incoming signal.

Talk Range

	Industrial	Multi-Level	Outdoor
Model	Inside steel/concrete industrial buildings	Inside multi-level buildings	Flat ground with no obstructions
UHF 2W	Up to 250,000 Sq. Ft.	Up to 20 Floors	Up to 6 Miles
UHF 1W	Up to 200,000 Sq. Ft.	Up to 15 Floors	Up to 5 Miles
VHF 2W	Up to 180,000 Sq. Ft.	Up to 10 Floors	Up to 6 Miles
VHF 1W	Up to 150,000 Sq. Ft.	Up to 8 Floors	Up to 5 Miles



Keypad Lock

1. To maintain settings and lock keypad, press and hold  for three seconds.
2. To unlock, press and hold  for three seconds.

Hands-Free Use/VOX

Motorola XTN radios can operate hands-free (VOX) when used with compatible VOX accessories. A short delay occurs between when you start talking and the radio transmits.

With Compatible VOX Accessories





1. Turn radio off.
2. Open accessory cover.
3. Insert plug of audio accessory firmly into accessory jack.
4. Turn radio on. Radio displays: . **If flashing and for initial use, please refer to "Setting Vox Sensitivity" on page 28.**
5. Lower radio volume BEFORE placing accessory near ear.
6. To transmit, speak into accessory microphone and to receive, stop talking.
7. You can disable VOX operation by pressing  or removing the audio accessory.



Note: To order accessories, refer to: www.motorola.com/radios/professional, call 1 (800) 448-6686, or contact your point of purchase.





Without Accessories

You can operate the Motorola XU2600 and XV2600 radios hands-free without a VOX accessory.

1. Enable VOX by pressing  while turning the radio on.  displays.
2. You can disable VOX operation temporarily by pressing ,  will flash.
3. A short press of  will re-enable VOX.
4. To disable VOX, turn radio off then back on.

Setting VOX Sensitivity

You can adjust the sensitivity of your radio's accessory or microphone during VOX operation (XU2600 and XV2600) to suit different operating environments. These menus appear only if the VOX feature is in use, which is indicated by .

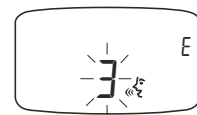

1. Press  until  appears. The radio also displays which VOX sensitivity you are setting:
 - E = External VOX (with audio accessory)
 - I = Internal VOX (without accessory; XU2600 and XV2600 only)
2. Press  or  to select the sensitivity level.
 - 0 = Off (VOX with accessories only, default settings)
 - 1 = Low sensitivity
 - 2 = Medium sensitivity
 - 3 = High sensitivity



External VOX

Monitoring a Channel





Check for channel activity.

1. Press and hold . You will hear static if the channel is clear and  will display.
2. Press  again to release.



Scanning (XU2600 and XV2600 only)

You can scan up to six channels and frequencies. When the radio detects activity, it stops scanning and locks in on the active channel. This allows you to talk and listen to the person transmitting without changing channels.

1. To start scanning, briefly press . Your radio displays  and begins to scroll through channels. When the radio detects channel activity, it stops on that channel and displays the signal strength indicator and the channel. You can talk to the person(s) transmitting without having to switch channels by pressing . If you press  while the radio is scanning, the radio transmits on the channel you selected before you activated scan.
2. To stop scanning, briefly press .

If no transmission occurs within five seconds, scanning resumes.

To scan a channel without interference eliminator codes, change the code for your set channel to  before you press and release .

Note: When you press , you hear all traffic, but may not be able to transmit back because the other person(s) may be using codes.

Scan Advancement / Nuisance Delete

Scan has several temporary features to make it easier to use.

Scan Advancement allows you to “skip” a busy channel to check for other activity.

- Press  to begin scanning again, but only temporarily.

Nuisance delete allows you to temporarily remove a channel from your scan list, it will return the next time you use the scan feature.

- Press and hold  to temporarily remove a channel from the scan list.

Programming Features

You can change the following features by entering the programming mode (**PROG**). To talk with someone on your two-way radios, these settings must match:

- Channel (XU2600 and XV2600 only)
- Frequency
- Interference Eliminator Code
- Scramble code
- Bandwidth (for optimal clarity)



You can also use **PROG** to set the following:

- Call tones
- Microphone Gain
- Scan List (XU2600 and XV2600 only)
- Available channels (XU2600 and XV2600 only)

Note: You cannot enter **PROG** while a VOX accessory is plugged into the radio.

Entering Programming Mode

You must enter Programming Mode to change your communication settings.

1. Press and hold   for three seconds while turning on your radio. The radio beeps and displays **PROG**.







XTN

31

Programming a Channel (XU2600 and XV2600 only)

Each channel has its own Frequency, Interference Eliminator Code, Scramble Code, and Bandwidth Settings.





Program each channel separately.

1. Select the channel that you will be programming.
2. The channel number flashes. **FREQ** and code displays alternately.
3. Press  or  to select the desired channel.
4. Press and hold  to exit **PROG**, or press  to continue.



Programming the Frequency

Sets the frequency that your radio will use. As you are matching your XTN radio to existing Spirit M-Series radios, enter Programming Mode as necessary, refer to page 34.

1. Press  to display **FREQ**. The frequency flashes.
2. Press  or  to select the desired frequency (See "Frequencies and Bandwidths" beginning on page 45).
3. Press and hold  to exit **PROG**, or press  to continue.



XTN

32

Programming the Interference Eliminator Code

The Interference Eliminator Code helps minimize interference by providing you with code combinations, which filter out static, noise, and unwanted messages.

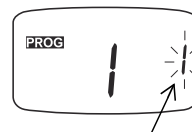

Interference Eliminator Code

1. Enter Programming Mode as necessary, refer to “Entering Programming Mode” on page 31.
2. Press until the Interference Eliminator Code display number begins to flash.
3. Press or to select the desired Code (See “Interference Eliminator Codes” beginning on page 48).
4. Press and hold to exit **PROG**, or press to continue.

Assigning Channels to Presets (XU2600 and XV2600 only)

Presets allow you to easily switch to more frequently-used channels.

1. Enter Programming Mode as necessary, refer to “Entering Programming Mode” on page 31.
2. Press or to select the desired channel.
3. Press and hold or to assign that channel to a preset, radio beeps to confirm. All of the channel settings are assigned to that preset button.
4. Press and hold to exit **PROG**, or press to continue.

XTN

33

Programming the Scramble Feature

(2-watt models only)

The scramble feature garbles the transmission for anyone listening without the same scramble setting. It does not guarantee confidentiality, but it increases privacy. The scramble feature is set individually for each channel.

1. Enter Programming Mode as necessary, refer to “Entering Programming Mode” on page 31.
2. Press until displays.
3. Press or to select 1, 2, or 3. Factory default is set to Off: . When you exit **PROG**, displays.
4. Press and hold to exit **PROG**.



Programming Bandwidth (when FCC allowable)

Some frequencies have selectable channel spacing, which must match other radios for optimal radio quality. Bandwidth settings are programmed for each channel.

1. Enter Programming Mode as necessary, refer to “Entering Programming Mode” on page 31.
2. Press until displays.
3. If flashes, press or to select **Hi** (25.0 kHz) or **L** (12.5 kHz) bandwidth. (See “Frequencies and Bandwidths” beginning on page 45). If does not flash, then you cannot select the bandwidth for this frequency.

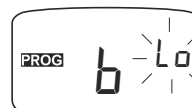

XTN





34

4. Press and hold  to exit **PROG**.

Note: Spirit GT radios operate at 12.5 kHz. The M Series radios may operate at 25.0 kHz or 12.5 kHz bandwidth if selectable. If you have questions on radio use, call 1-800-448-6686.





Programming the Available Channel (XU2600 and XV2600 only)

For applications requiring fewer channels, you can reduce the number of available channels from 6. Older XTN radios may not have this feature. Call 1-800-448-6686 for more information.

1. Enter Programming Mode as necessary, refer to “Entering Programming Mode” on page 31.
2. Press  until **CH** appears.
3. Press  or  to select the number of channels you want available.
4. Press and hold  to exit **PROG**.



Note: Programming settings for channels made unavailable are retained by the radio.





Programming Call Tones

Your radio can transmit call tones to other radios in your group so you can alert them that you are about to talk. The default is set to  (off) or you may choose , , or  to choose a distinctive call tone.



1. Enter Programming Mode as necessary, refer to “Entering Programming Mode” on page 31.









2. Press  until **CA** displays.
3. Press  or  to hear and select the call tone you want.

Note: The default is set to  (off) or you may choose , , or  to choose a distinctive call tone.

4. Press and hold  to exit **PROG**.
Once enabled, press  to transmit the call tone to others.

Programming Microphone Gain



The sensitivity of your radio’s microphone can be adjusted to suit different users or operating environments.

1. Enter Programming Mode as necessary, refer to “Entering Programming Mode” on page 31.
2. Press  until  and **G** (Gain) display.
3. Press  or  to select the sensitivity level.
 = High sensitivity, for quiet environments
 = Medium sensitivity, the default setting
 = Low sensitivity, for loud environments
4. Press and hold  to exit **PROG**.





Editing the Scan List (XU2600 and XV2600 only)

To avoid hearing transmissions from unnecessary channels while scanning and to decrease scan time, you can edit the scan list to skip unneeded channels.

1. Enter Programming Mode as necessary, refer to “Entering Programming Mode” on page 31.
2. Press  until \approx displays and the channel and \mathcal{H} or n flashes.
3. Press \downarrow or \uparrow to increase or decrease the channel.
4. Press  to display either:
 \mathcal{H} to include the channel
 n to exclude the channel
5. Press and hold  to exit **PROG**.



Cloning

You can duplicate **XTN** Series radio settings from one radio to another by using the optional accessory 53879 Multi-Unit Charger (MUC). Please refer to the MUC User's Guide included with this accessory.

1. To enter the Programming Mode on the source radio, press and hold   for three seconds while turning on your radio. The radio beeps and displays **PROG**.
2. Place the source radio in one of the front pockets of the MUC.

XTN

37

3. Turn on the target radio and place it directly behind the source radio in the MUC.
4. Press and hold  on the source radio. The source radio enters Cloning Mode and transmits its settings to the target radio. Either P for pass or F for fail appears on the source radio and the target radio displays all icons if cloning was successful.
5. Turn the target radio off and back on again to use.
6. To clone additional radios, repeat steps 3 and 5.
7. Exit **PROG** on the source radio by holding down .

Source radio



Target radio



Note: You can clone only one radio at a time.

The MUC does not need to be plugged in for Cloning feature to work.



Radios must be of the same band; UHF or VHF. Also, multi-channel models can clone to single-channel radios, but only the first channel is cloned.



XTN

38

Advanced Features

You can set the following features by pressing and holding additional button(s) **while you turn on your radio.**

To Do This	Press this Key While Turning On the Radio	Default Setting
Turn Keypad Tones on/off You can disable keypad beeps for silent menu operation.		On
Turn End-of-Transmission Tone on/off When enabled, your two-way radio transmits a tone when you finish transmitting. It's like saying "Roger" or "Over." Note: If Keypad Tones are off, you will not hear the end-of-transmission tone but it is transmitted (if enabled).		Off

To Do This	Press this Key While Turning On the Radio	Default Setting
Turn Battery Save on/off Decreases attack time, which is the brief period of time between when the radio receives a transmission on its frequency and broadcasts audio. Turning Battery Save off decreases battery life by approximately 20%.		On
Toggle Phase Shift Changes your phase shift for optimal communication with other Motorola radios. 180° XTN Series (factory default), M Series, Spirit M-Series, and Radius SP21 240° Spirit HP and Radius SP50		180°
Restore Factory Defaults Returns your radio to its original factory settings to verify proper operation. Refer to page 25 for factory default settings.		---

Troubleshooting

Symptom	Try This:
No Power	Recharge or replace battery 53871 battery (NTN8971 or NNTN4190). Reposition or replace alkaline batteries. For Nickel-Metal Hydride batteries, "Installing the Nickel-Metal Hydride Battery" on page 17 or "Battery and Charging Options" on page 22.
Message not transmitted	Make sure  is completely pressed while transmitting. Recharge, replace and/or reposition batteries. Verify the transmit light is illuminated while speaking.
Hearing other noises or conversation on a channel	Frequency or Interference Eliminator Code may be in use, change on all radios if possible. See "Programming the Interference Eliminator Code" on page 33.
Poor Audio Quality	Scramble Code is On (2-watt models only), and/or setting does not match other radios' settings. See "Programming the Scramble Feature" on page 34. Bandwidth of radios does not match. See "Programming Bandwidth (when FCC allowable)" on page 34.

Symptom	Try This:
Limited talk range	Steel and/or concrete structures, heavy foliage, buildings or vehicles decrease range. Check for clear line of sight to improve transmission. See "Talk Range" on page 26. Wearing radio close to body such as in a pocket or on a belt decreases range. Change location of radio.
Message not received	Confirm radios have the same Channel, Frequency, Interference Eliminator Code and Scramble Code settings, depending upon model. See "Programming Features" on page 31. Recharge, replace and/or reposition batteries. Move to another location. Obstructions and operating indoors, or in vehicles may decrease range. Verify that the radio is not in Scan mode. See "Scanning (XU2600 and XV2600 only)" on page 29.
Heavy static or interference	Radios are too close, they must be at least five feet apart. Radios are too far apart or obstacles are interfering with transmission.
Keypad locked	Unlock by holding  for three seconds.

Symptom	Try This:
Low batteries	Recharge or replace battery or batteries. Extreme operating temperatures affect battery life. See "Battery Life" on page 24.
Charger light does not come on	Reinsert radio/battery. Clean battery/charger contacts. Verify that the charging pin is inserted correctly. AA cells installed in radio, remove and replace with NiMH battery.
Low battery meter reading although new batteries are installed	Verify that the radio is set to the correct battery type (Single-cell batteries only). See "Alkaline Batteries" on page 22.
Cannot activate VOX	Feature not set and on. See "Hands-Free Use/VOX" on page 27. Sensitivity set to  . See "Setting VOX Sensitivity" on page 28.
Cannot enter PROG mode	Unplug any audio accessories and retry.

Use and Care



Use a soft damp cloth to clean the exterior.



Do not immerse in water.



Do not use alcohol or cleaning solutions.

If the radio is submerged in water...



Turn radio off and remove batteries.



Dry with soft cloth.



Do not use radio until completely dry.

Frequencies and Bandwidths

The charts on the next few pages provide frequency information. These charts are useful when using Motorola **XTN** Series two-way radios with other business radios. Frequency Display Number is identical to Spirit M, GT and S-Series frequency position (where applicable).

VHF Frequencies

Display Number	Frequency (MHz)	Bandwidth
1	151.6250	25.00
2	151.9550	25.00
3	154.5700	25.00
4	154.6000	25.00
5	151.7000	12.5/25.0
6	151.7600	12.5/25.0
*7	151.8200	12.5/25.0
*8	151.8800	12.5/25.0
*9	151.9400	12.5/25.0
10	151.5125	25.00
11	151.6550	25.00
12	151.6850	25.00
13	151.7150	25.00
14	151.7450	25.00
15	151.7750	25.00

Display Number	Frequency (MHz)	Bandwidth
16	151.8650	25.00
17	151.8950	25.00
18	151.9250	25.00
19	152.7000	25.00
20	154.4900	25.00
21	154.5150	25.00
22	154.5275	25.00
23	154.5400	25.00
24	154.6000	25.00
25	154.6550	25.00
26	158.4000	25.00
27	158.4075	25.00

***Note:** Due to FCC regulations, these frequencies transmit at only 1 watt.

XTN

45

UHF Frequencies

Display Number	Frequency (MHz)	Bandwidth
1	464.5000	12.5/25.0
2	464.5500	12.5/25.0
3	467.7625	12.5
4	467.8125	12.5
5	467.8500	12.5/25.0
6	467.8750	12.5/25.0
7	467.9000	12.5/25.0
8	467.9250	12.5/25.0
9	461.0375	12.5
10	461.0625	12.5
11	461.0875	12.5
12	461.1125	12.5
13	461.1375	12.5
14	461.1625	12.5

Display Number	Frequency (MHz)	Bandwidth
15	461.1875	12.5
16	461.2125	12.5
17	461.2375	12.5
18	461.2625	12.5
19	461.2875	12.5
20	461.3125	12.5
21	461.3375	12.5
22	461.3625	12.5
23	462.7625	12.5
24	462.7875	12.5
25	462.8125	12.5
26	462.8375	12.5
27	462.8625	12.5
28	462.8875	12.5

XTN

46

UHF Frequencies (Continued)

Display Number	Frequency (MHz)	Bandwidth
29	462.9125	12.5
30	464.4875	12.5
31	464.5125	12.5
32	464.5375	12.5
33	464.5625	12.5
34	466.0375	12.5
35	466.0625	12.5
36	466.0875	12.5
37	466.1125	12.5
38	466.1375	12.5
39	466.1625	12.5
40	466.1875	12.5
41	466.2125	12.5
42	466.2375	12.5

Display Number	Frequency (MHz)	Bandwidth
43	466.2625	12.5
44	466.2875	12.5
45	466.3125	12.5
46	466.3375	12.5
47	466.3625	12.5
48	467.7875	12.5
49	467.8375	12.5
50	467.8625	12.5
51	467.8875	12.5
52	467.9125	12.5
53	469.4875	12.5
54	469.5125	12.5
55	469.5375	12.5
56	469.5625	12.5

XTN

47

Interference Eliminator Codes

Display Number	Code (Hz)
1	67.0
2	71.9
3	74.4
4	77.0
5	79.7
6	82.5
7	85.4
8	88.5
9	91.5
10	94.8
11	97.4
12	100.0
13	103.5

Display Number	Code (Hz)
14	107.2
15	110.9
16	114.8
17	118.8
18	123.0
19	127.3
20	131.8
21	136.5
22	141.3
23	146.2
24	151.4
25	156.7
26	162.2

Display Number	Code (Hz)
27	167.9
28	173.8
29	179.9
30	186.2
31	192.8
32	203.5
33	210.7
34	218.1
35	225.7
36	233.6
37	241.8
38	250.3

Carrier Squelch (0) disables interference eliminator codes.

XTN

48

Digital Interference Eliminator Codes

Display Number	Digital Code
39	023
40	025
41	026
42	031
43	032
44	043
45	047
46	051
47	054
48	065
49	071
50	072
51	073
52	074
53	114

Display Number	Digital Code
54	115
55	116
56	125
57	131
58	132
59	134
60	143
61	152
62	155
63	156
64	162
65	165
66	172
67	174
68	205

Display Number	Digital Code
69	223
70	226
71	243
72	244
73	245
74	251
75	261
76	263
77	265
78	271
79	306
80	311
81	315
82	331
83	343

XTN

49

Digital Interference Eliminator Codes (Continued)

Display Number	Digital Code
84	346
85	351
86	364
87	365
88	371
89	411
90	412
91	413
92	423
93	431
94	432
95	445
96	464

Display Number	Digital Code
97	465
98	466
99	503
100	506
101	516
102	532
103	546
104	565
105	606
106	612
107	624
108	627
109	631







Display Number	Digital Code
110	632
111	654
112	662
113	664
114	703
115	712
116	723
117	731
118	732
119	734
120	743
121	754

XTN

50

Verifying the M-Series Frequency and Code Setting

The **XTN** Series Two-Way radio replaces the Spirit M-Series radio. The factory default settings for both radios are identical. However, existing radios may have been programmed to different settings. To program your **XTN** Series radio to talk with an M-Series radio, verify or change your M-Series settings as follows.

1. Press and hold  while you turn on the radio to enter programming mode.
The radio announces current frequency for that channel. For example: "frequency one."
2. If desired, press  to scroll through the frequencies.
The radio announces each frequency as you scroll. For example: "two...three..."
3. Release  when you reach the desired frequency.
4. Press  to select and save the frequency setting.
The radio announces current code setting. For example: "code two nine"
5. Press  to scroll through the codes.
The radio announces each code as you scroll. For example: "three zero...three one"
6. Release  when you reach the desired code.
7. Press  to select and save the code setting.

XTN

51

Motorola Limited Warranty for the United States and Canada

What Does this Warranty Cover?

Subject to the exclusions contained below, Motorola, Inc. warrants its telephones, pagers, and consumer and professional two-way radios (excluding commercial, government or industrial radios) that operate via Family Radio Service or General Mobile Radio Service, Motorola-branded or certified accessories sold for use with these Products ("Accessories") and Motorola software contained on CD-ROMs or other tangible media and sold for use with these Products ("Software") to be free from defects in materials and workmanship under normal consumer usage for the period(s) outlined below. This limited warranty is a consumer's exclusive remedy, and applies as follows to new Motorola Products, Accessories and Software purchased by consumers in the United States or Canada, which are accompanied by this written warranty:

Products and Accessories

Products Covered	Length of Coverage
Products and Accessories as defined above, unless otherwise provided for below.	One (1) year from the date of purchase by the first consumer purchaser of the product unless otherwise provided for below.
Decorative Accessories and Cases. Decorative covers, bezels, PhoneWrap™ covers and cases.	Limited lifetime warranty for the lifetime of ownership by the first consumer purchaser of the product.
Professional Two-way Radio Accessories.	One (1) year from the date of purchase by the first consumer purchaser of the product.
Products and Accessories that are Repaired or Replaced.	The balance of the original warranty or for ninety (90) days from the date returned to the consumer, whichever is longer.

Exclusions

Normal Wear and Tear. Periodic maintenance, repair and replacement of parts due to normal wear and tear are excluded from coverage.

Batteries. Only batteries whose fully charged capacity falls below 80% of their rated capacity and batteries that leak are covered by this limited warranty.

Abuse & Misuse. Defects or damage that result from: (a) improper operation, storage, misuse or abuse, accident or neglect, such as physical damage (cracks, scratches, etc.) to the surface of the product resulting from misuse; (b) contact with liquid, water, rain, extreme humidity or heavy perspiration, sand, dirt or the like, extreme heat, or food; (c) use of the Products or Accessories for commercial purposes or subjecting the Product or Accessory to abnormal usage or conditions; or (d) other acts which are not the fault of Motorola, are excluded from coverage.

Use of Non-Motorola Products and Accessories. Defects or damage that result from the use of Non-Motorola branded or certified Products, Accessories, Software or other peripheral equipment are excluded from coverage.

Unauthorized Service or Modification. Defects or damages resulting from service, testing, adjustment, installation, maintenance, alteration, or modification in any way by someone other than Motorola, or its authorized service centers, are excluded from coverage.

Altered Products. Products or Accessories with (a) serial numbers or date tags that have been removed, altered or obliterated; (b) broken seals or that show evidence of tampering; (c) mismatched board serial numbers; or (d) nonconforming or non-Motorola housings, or parts, are excluded from coverage.

Communication Services. Defects, damages, or the failure of Products, Accessories or Software due to any communication service or signal you may subscribe to or use with the Products Accessories or Software is excluded from coverage.

Software

Products Covered	Length of Coverage
Software. Applies only to physical defects in the media that embodies the copy of the software (e.g. CD-ROM, or floppy disk).	Ninety (90) days from the date of purchase.

Exclusions

Software Embodied in Physical Media. No warranty is made that the software will meet your requirements or will work in combination with any hardware or software applications provided by third parties, that the operation of the software products will be uninterrupted or error free, or that all defects in the software products will be corrected.

Software NOT Embodied in Physical Media. Software that is not embodied in physical media (e.g. software that is downloaded from the internet), is provided “as is” and without warranty.

Who is Covered?

This warranty extends only to the first consumer purchaser, and is not transferable.

What Will Motorola Do?

Motorola, at its option, will at no charge repair, replace or refund the purchase price of any Products, Accessories or Software that does not conform to this warranty. We may use functionally equivalent reconditioned/refurbished/pre-owned or new Products, Accessories or parts. No data, software or applications added to your Product, Accessory or Software, including but not limited to personal contacts, games and ringer tones, will be reinstalled. To avoid losing such data, software and applications please create a back up prior to requesting service.

How to Obtain Warranty Service or Other Information?

USA	Phones 1-800-331-6456 Two-Way Radios 1-800-448-6686 Pagers 1-800-548-9954
Canada	All Products 1-800-461-4575
TTY	TTY 1-888-390-6456
For Accessories and Software , please call the telephone number designated above for the product with which they are used.	

You will receive instructions on how to ship the Products, Accessories or Software, at your expense, to a Motorola Authorized Repair Center. To obtain service, you must include: (a) a copy of your receipt, bill of sale or other comparable proof of purchase; (b) a written description of the problem; (c) the name of your service provider, if applicable; (d) the name and location of the installation facility (if applicable) and, most importantly; (e) your address and telephone number.

What Other Limitations Are There?

ANY IMPLIED WARRANTIES, INCLUDING WITHOUT LIMITATION THE IMPLIED WARRANTIES OF MERCHANTABILITY AND FITNESS FOR A PARTICULAR PURPOSE, SHALL BE LIMITED TO THE DURATION OF THIS LIMITED WARRANTY, OTHERWISE THE REPAIR, REPLACEMENT, OR REFUND AS PROVIDED UNDER THIS EXPRESS LIMITED WARRANTY IS THE EXCLUSIVE REMEDY OF THE CONSUMER, AND IS PROVIDED IN LIEU OF ALL OTHER WARRANTIES, EXPRESS OR IMPLIED. IN NO EVENT SHALL MOTOROLA BE LIABLE, WHETHER IN CONTRACT OR TORT (INCLUDING NEGLIGENCE) FOR DAMAGES IN EXCESS OF THE PURCHASE PRICE OF THE PRODUCT, ACCESSORY OR SOFTWARE, OR FOR ANY INDIRECT, INCIDENTAL, SPECIAL OR CONSEQUENTIAL DAMAGES OF ANY KIND, OR LOSS OF REVENUE OR PROFITS, LOSS OF BUSINESS, LOSS OF INFORMATION OR DATA, SOFTWARE OR APPLICATIONS OR OTHER FINANCIAL LOSS ARISING OUT OF OR IN CONNECTION WITH THE ABILITY OR INABILITY TO USE THE PRODUCTS, ACCESSORIES OR SOFTWARE TO THE FULL EXTENT THESE DAMAGES MAY BE DISCLAIMED BY LAW.

Some states and jurisdictions do not allow the limitation or exclusion of incidental or consequential damages, or limitation on the length of an implied warranty, so the above limitations or exclusions may not apply to you. This warranty gives you specific legal rights, and you may also have other rights that vary from state to state or from one jurisdiction to another.

Laws in the United States and other countries preserve for Motorola certain exclusive rights for copyrighted Motorola software such as the exclusive rights to reproduce and distribute copies of the Motorola software. Motorola software may only be copied into, used in, and redistributed with, the Products associated with such Motorola software. No other use, including without limitation disassembly of such Motorola software or exercise of the exclusive rights reserved for Motorola, is permitted.

Software Copyright Notice

The Motorola products described in this manual may include copyrighted Motorola and third party software stored in semiconductor memories or other media. Laws in the United States and other countries preserve for Motorola and third party software providers certain exclusive rights for copyrighted software, such as the exclusive rights to distribute or reproduce the copyrighted software. Accordingly, any copyrighted software contained in the Motorola products may not be modified, reverse-engineered, distributed, or reproduced in any manner to the extent allowed by law. Furthermore, the purchase of the Motorola products shall not be deemed to grant either directly or by implication, estoppel, or otherwise, any license under the copyrights, patents, or patent applications of Motorola or any third party software provider, except for the normal, non-exclusive, royalty-free license to use that arises by operation of law in the sale of a product.

Patent Notice

This product is covered by one or more of the following United States patents.

5896277 5894292 5864752 5699006 5742484 D408396 D399821 D387758
D389158 5894592 5893027 5789098 5734975 5861850 D395882 D383745
D389827 D389139 5929825 5926514 5953640 6071640 D413022 D416252
D416893 D433001

Export Law Assurances

This product is controlled under the export regulations of the United States of America and Canada. The Governments of the United States of America and Canada may restrict the exportation or re-exportation of this product to certain destinations. For further information contact the U.S. Department of Commerce or the Canadian Department of Foreign Affairs and International Trade.

A			
Audio accessories	27	Cloning.....	37
Adjust volume.....	19, 20	Code	
Advanced features	39	Interference eliminator.....	33
Alkaline batteries.....	22	D	
B		Diagram	
Bandwidth.....	34	Function	20
Basic operations.....	20	Drop-in charger	23
Battery		E	
Alkaline	22	End-of-transmission tone	39
Install.....	22	External VOX	28, 36
Charge		F	
Alkaline	18	FCC licensing information.....	5
NiMH	18	Frequency	
Meter.....	24	Setting	32
C		Functions.....	20
Call display	35	H	
Channel		Hands-free use.....	28, 36
Activity	29	I	
Charger		Information	
Drop-in	23	Safety	7
Multi-unit.....	37	Install	
Plug-in	23	Alkaline batteries	22
Charging	19	NiMH battery	17
		Interference eliminator code	33

Internal VOX.....	28, 36	Diagram	20
Introduction	1	Display.....	24
K		Functions and settings	21
Keypad tones	39	Off	19
L		On	39
Licensing information		Operating.....	26
FCC	5	Out of range.....	26
M		Range	
Meter		Talking.....	26
Battery	24	S	
Microphone gain	28, 36	Safety information	7
Monitor signal strength	26, 29	Scan.....	42
M-Series	32, 40, 51	Scan list.....	29
O		Sensitivity	28, 36
Obstacles	26	Setting	
Operating radio.....	19	Battery type	37
P		Call tone	35
Plug		Channel.....	32
Audio.....	27	Scramble code	34
Plug-in charger	18	VOX sensitivity level	28, 36
Product-related questions	2	Signal strength indicator	26, 29
Programming mode	31	T	
R		Talk range	26
Radio			
Clean	44		

U		Internal	28
Use and care.....	44	Sensitivity level.....	28, 36
User guide		W	
Large-print.....	2	Warranty	52
V		Website	
VOX		Accessories	27
External.....	27		

XTN Series Programming Quick Reference

Function	Appearance
----------	------------

Press & hold for 3 sec. and turn on radio. **PROG** displays.

***Channel** Use \downarrow or \uparrow for 1 through 6.

Frequency Press until **FREQ** displays. To change, press \downarrow or \uparrow .

*depending upon model

Interference Eliminator Code Appears after **FREQ** shows. Set for each channel.

***Scramble Code** Press until displays. Must be set to same code for all radios.

Bandwidth Press until **b** displays. Press \downarrow or \uparrow to select **H** (25.0 kHz) or **L** (12.5 kHz).
Note: If bandwidth is not flashing, it is not selectable on the chosen frequency.

*depending upon model

XTN Series Programming Quick Reference

Radio On	Visual	as needed, then \downarrow or \uparrow
----------	--------	--

***Available Channels** Press until **CH** displays. Press \downarrow or \uparrow to select number of available channels.

Call Tone Choose 1, 2, 3, or = Off (default).

Microphone Gain Choose:
1 Low Sensitivity
2 Medium Sensitivity
3 High Sensitivity

***Scan List** Press \downarrow or \uparrow to select channel, then choose **y** (yes) to include or **n** (no) to exclude by pressing .

*depending upon model

- **Extend Your Productivity**
Provides a cost-effective solution to onsite communication needs. Designed for heavy duty, everyday industrial use. Well suited for construction, manufacturing, security, property management, retail, and more.
- **Rugged MOTOROLA Quality**
Shock/drop/temperature tested to meet Motorola's high standards.
- **Weather/Dust Resistant**
Designed to meet IP-54 rating
- **Designed to meet Military Specs**
810 C, D, E & F
- **Dependable Indoor/Outdoor Coverage**
Will provide a communication range* of up to 250,000 sq. ft. or 20 floors and up to 6 miles.
*Range will vary based on terrain and conditions and model selected.

- **Simple and Easy to Operate**
Allows one-to-one or group communication at the push of a button. You can even customize the number of channels you want to operate on (XU2600 and XV2600). With no phone numbers to dial, plus the Manager Lock feature, there's little to no training needed for your staff to be fully up to speed.
- **Cost Efficient**
No monthly fees to pay and no service contracts. Compatible with Motorola Spirit® radios and M Series audio accessories.

- **Cloning Capability**
- **Business Exclusive Frequencies**
Frequencies set aside exclusively for business-only use. FCC License is required.
- **38 PL Codes, 83 Digital PL Codes**
- **Hands-Free Mode (VOX)**
Advanced voice activation (VOX) lets you talk hands-free; XV2600 and XU2600 models do not require accessories.
- **Voice Compression Technology**
Helps provide better sound at longer distances.
- **1-Year Limited Warranty**
For details, please call: 1-800-448-6686.

Radio Specification Chart

Transmit Power:	1 or 2 Watts
Alkaline Battery Life:	Approximately 24 hrs 1W/22 hrs 2W
NiMH Battery Life:	Approximately 15 hrs 1W/13 hrs 2W

- **Accessories for XTN Series**
Brochure included - Convenient audio, power and charging accessories are available from your point-of-sale or www.motorola.com/radios/professional

MOTOROLA, the Stylized M Logo, XTN Series and all other trademarks indicated as such herein are trademarks of Motorola, Inc. © Reg. U.S. Pat. & Trm. Off. All other product or service names are the property of their respective owners. © 2001, 2002 Motorola, Inc. All rights reserved. Printed in the U.S.A.

Motorola® XTN Series



Proof of Purchase

FCC
License Required

⚠ WARNING CHOKING HAZARD
SMALL PARTS
Not for children under 3 years.
This product is not intended to be used as a toy or plaything.