



OPERATOR MANUAL
Mini-Bank 1500™

TABLE OF CONTENTS

1. INTRODUCTION
 - 1.1 Features
 - 1.1.1 About the Mini-Bank 1500™
 - 1.2 Specifications
 - 1.2.1 Mini-Bank 1500™ Specifications
 - 1.2.1.1 Dimensions
 - 1.2.1.2 Component Locations
 - 1.2.1.3 LCD & Customer Keypad
 - 1.2.1.4 Cash Dispensing Unit
 - 1.2.1.5 Receipt Printer
 - 1.2.1.6 Main Control Board
 - 1.2.1.7 Operating Environment
 - 1.3 Warranty/Service
2. INSTALLATION
 - 2.1 Mini-Bank 1500™ Installation
 - 2.1.1 Unpacking
 - 2.1.2 Physical Installation
 - 2.1.3 Hardware Setup
3. PROGRAMMING
 - 3.1 Initial Setup
 - 3.1.1 Accessing the Operator Function Menu
 - 3.1.2 When An Error Occurs
 - 3.1.3 Mini-Bank Keypad
 - 3.1.4 NanoCash Keypad
 - 3.2 The Host Setup Menu
 - 3.2.1 Key Management
 - 3.2.2 Set Host Telephone Number
 - 3.2.3 Set Terminal ID / Routing ID Number
 - 3.2.4 Health Check Message
 - 3.2.5 Connect Timer
 - 3.2.6 Remote Monitor
 - 3.2.7 Trial Day Total
 - 3.3 The System Setup Menu
 - 3.3.1 Set Clock
 - 3.3.2 Speaker / LCD Control
 - 3.3.3 ISO 1,2,3 En/Disable
 - 3.3.4 Optional Languages
 - 3.3.5 Change Passwords
 - 3.3.6 Modem Setup
 - 3.3.7 Modem Test
 - 3.3.8 RMS Ring Count
 - 3.4 Customer Setup Menu
 - 3.4.1 Change Message
 - 3.4.2 BIN Lists
 - 3.4.3 Optional Function
 - 3.4.4 Receipt Setup
 - 3.4.5 Surcharge Mode
 - 3.4.6 Advertisements

- 3.5 Transaction Setup
 - 3.5.1 Dispense Limit
 - 3.5.2 Denomination
 - 3.5.3 Fast Cash
 - 3.5.4 Low Currency Check
- 4. OPERATION
 - 4.1 Opening and Closing
 - 4.1.1 Mini-Bank
 - 4.1.1.1 Opening the Security Door
 - 4.1.1.2 Closing the Security Door
 - 4.1.1.3 Opening the Front Panel
 - 4.1.1.4 Closing the Front Panel
 - 4.1.1.5 Operating and Changing the Combination Lock
 - 4.2 Cash Operations
 - 4.2.1 Mini-Bank
 - 4.2.1.1 Adding Cash to the Cassette
 - 4.2.1.2 Emptying the Reject Bin
 - 4.2.1.3 Loading the Receipt Printer
 - 4.3 Settlement Menu
 - 4.4 Journal Menu
 - 4.5 Reports Menu
- 5. DIAGNOSTICS
 - 5.1 Diagnostics Menu
- 6. CUSTOMER TRANSACTIONS
 - 6.1 Opening Procedure
 - 6.2 Withdrawal Transaction
 - 6.3 Balance Inquiry Transaction
 - 6.4 Transfer Transaction
 - 6.5 Closing Procedure
 - 6.6 Error Recovery
- APPENDIX
 - A. Error Codes
 - B. Pin Pad layout for Master Key / Download Mode / Clear NVRAM
 - C. TDES Master Key installation
 - D. Advertisement Graphics

Mini-Bank 1500™

1.1 FEATURES

1.1.1 ABOUT THE Mini-Bank 1500™

The Tranax Mini-Bank1500™ represents the absolute best value in retail ATMs. The Mini-Bank 1500™ inherits the unsurpassed reliability and quality of the MB-1000 and 2000. An eye-catching design coupled with numerous enhancements to ensure ADA, TDES and VISA PIN security compliance, makes the Mini-Bank 1500™ the clear choice for any retail ATM deployment.

The new Mini-Bank 1500™ has standard features such as voice guidance, encrypted pin pad and 56K modem. It offers a range of options to custom configure an ATM solution for any location. No other ATM manufacturer offers the same level of integrated design and built in flexibility. The Tranax Mini-Bank 1500™ delivers high quality and high performance at a value price.

H/W FEATURES

- UL 291 Business Hour Service Vault featuring reinforced steel bottom.
- Dial combination lock
- Electronic combination lock (optional)
- 320 x 240 resolution of back-lit LCD / color display (option)
- Dial-up telephone line instead of expensive leased line
- 1100 new note capacity
- 2000, 4000 new note capability (optional)
- DIP type magnetic card reader
- Thermal receipt printer for high speed printing
- Modular design for easy maintenance

FUNCTIONAL FEATURES

- Cashworks™ Check Cashing (optional)
- Electronic journal stores up to 2000 transactions
- Supports English, Spanish, French, Korean, Japanese (optional)
- Availability for 7 on screen advertisement graphics
- Detailed average history report feature
- Error code description for easy service

1.2 SPECIFICATIONS

Mini-Bank 1500™ SPECIFICATIONS

1.2.1 Dimensions

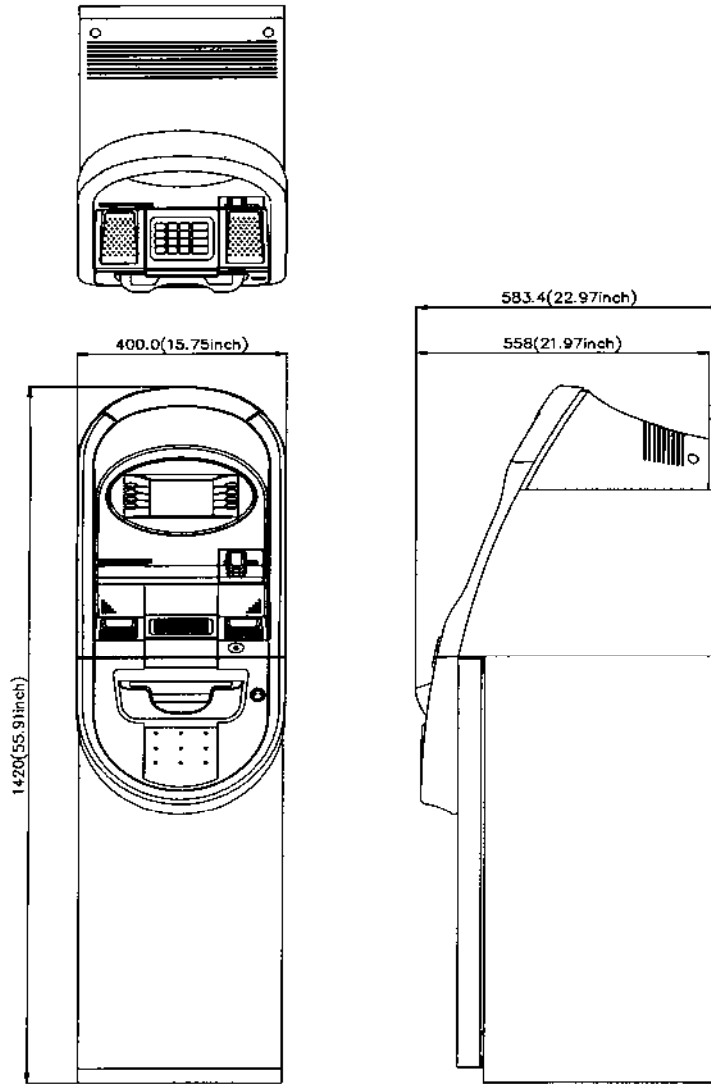

Fig. 1 Mini-Bank Dimensions

WEIGHT: 269 lbs.

1.2.2 LCD & Customer Keypad



Fig. 3 LCD & Customer Keypad

LCD

Screen Size: 6"
Mono/Color (optional)
Resolution: 320 x 240
Display Characters: 40 x 15 (Standard Characters)
8 Menu Keys

KEYPAD

Lab Certified VISA compliant EPP (Encrypting Pin Pad)
10 Alphanumeric, ◀, ▶, CANCEL, CLEAR, ENTER, BLANK Keypads
Each Keypad has integral raised Braille symbols

Voice Guidance Port

Voice assisted operation available through the headphone jack on the front bezel

1.2.3 Cash Dispensing Unit

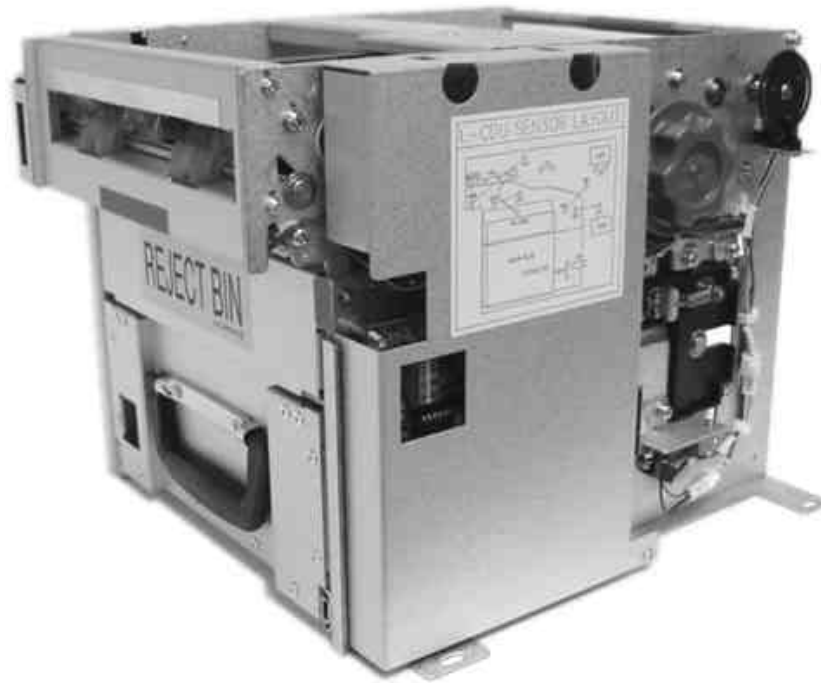

Cash Dispensing Unit
(Standard drawer type)

CASH DISPENSING UNIT

Dispensing Speed: 4 notes/second

Capacity of 1100 new notes per tray (standard dispenser)

Capacity of optional dispensers* depending on model.

Reject Bin with capacity of 200 notes

Low Level Cassette Detection (not available in 1000 note cassette configuration)

Double note detect module

*Optional dispensers include:

1000 note removable cassette

2000 note removable cassette

4000 note removable dual cassette

1.2.4 Receipt Printer

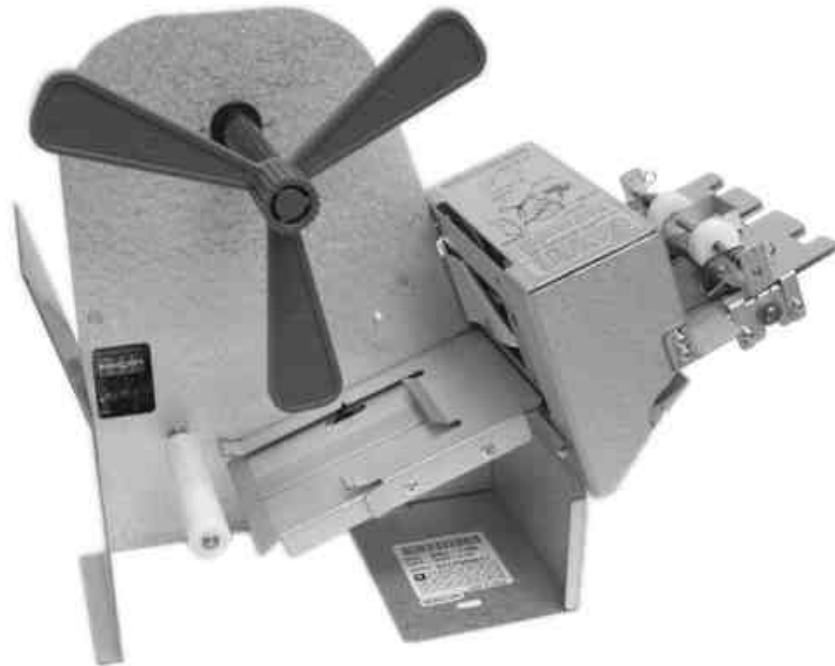

Receipt Printer

RECEIPT PRINTER

Thermal line printer
36 characters/line
Semi-automatic roll paper setting
Motorized front push rollers

PAPER SPECIFICATIONS

One sided thermal paper
Factory paper is thermal side out (but either way will work)
7.0 inch outside diameter roll
3.125" inch wide
Core inside diameter 11/16 inch
21# weight (paper thickness)

1.2.5 Main Control Board

Modem: 56,000 bps dial-up modem (standard)
Electronic Journal: +/- 2,000 transactions
Battery back-up for set-up parameters (NVRAM)
Real time clock
1MB RAM

1.2.6 Operating Environment

POWER REQUIREMENTS

110/220 VAC \pm 10%, 50/60 Hz, 250 Watts

POWER CONNECTIONS

For warranty purposes, the Mini-Bank 1500™ series ATM must be connected to a dedicated power circuit. This circuit must consist of line, neutral, and ground leads connected directly to the power circuit breaker panel. This circuit should not be shared with any other equipment. Use of a surge protector or uninterruptible power supply is recommended.

PHONE LINE REQUIREMENTS

The Mini-Bank series ATM should be connected to a dedicated phone line. This line must be a direct dial "tone" or "pulse" line that is equipped with a standard telephone wall jack (RJ-11). This line cannot be shared with any other equipment at the location. Use of shielded (CAT5) phone cable is recommended for best performance and to reduce the chance of interference.

TEMPERATURE

In storage : 32°F - 123°F (0°C ~ 49°C)
While operating : 40°F - 95°F (5°C ~ 35°C)

HUMIDITY

In storage : 10% < RH < 90%, non-condensed
While operating : 15% < RH < 85%, non-condensed

1.3 WARRANTY/SERVICE

MANUFACTURERS WARRANTY

Tranax Technologies, Inc. provides a limited one-year parts warranty and a limited 30 day labor warranty for the MiniBank series ATM. Tranax guarantees your MiniBank ATM to be free from defects in materials and workmanship.

The one-year parts warranty and 30-day labor warranty periods will begin 15 days from the shipping date.

WHAT IS COVERED:

- Cash Dispensing Unit (CDU) and Cash Cassette
- Receipt printer (SHU)
- LCD module
- Magnetic Card Reader (MCR)
- EPP Keypad
- Power Supply
- Mainboard (CE)
- Lock and locking mechanism ****LIMITED 90 DAY WARRANTY****
Dial and Electronic locks will be covered by a limited 90-day warranty provided the warranty registration card is completed and returned to Tranax within 10 days of installation. Should the lock fail under normal use, Tranax will replace the lock only. Services required to open the vault and or replace the lock are at the expense of the ATM owner.

WHAT IS NOT COVERED:

- Power cable and modem cable
- Key lock and key
- Plastic Bezels
- Software upgrade
- Receipt printer jam
- Note jam
- Forgotten password or combination of lock
- Any damages from misuse, improper installation, and vandalism
- Any damages from "brown out" or low power, lightning, or any other acts of God

Your distributor/dealer may offer an enhanced or extended warranty in addition to the original manufacturers one-year warranty. Once the manufacturers warranty has expired, all claims for warranty service must be resolved directly between the distributor/dealer and the ATM owner. Tranax will only honor the extended warranty of a MiniBank ATM that is registered in the Tranax Extended Part Replacement (EPR) warranty program.

OBTAINING SERVICE: If you have any problems or questions about your Tranax ATM, your dealer or distributor is your primary contact for assistance/service. Your manufacturers warranty is provided through your dealer or distributor.

SECTION 2: INSTALLATION

2.1 MINI-BANK 1500™ INSTALLATION

2.1.1 UNPACKING

Step 1

Once the ATM is unpackaged, do not discard the packaging materials until you have verified any shipping damage claim. Contact your distributor immediately if you see any shipping damage.

Step 2

Verify the contents carefully with the packing list to be sure all items listed are included. Notify your distributor of any shortages.

2.1.2 PHYSICAL INSTALLATION

To install the Mini-Bank 1500™ ATM, perform the following steps:

Step 1

Place the system on a flat surface. The system has a tendency to tip over if the surface is over 10 degrees. Be careful when opening the top or bottom of the machine as it will be off balance.

Step 2

Locate the Anchor Template in the bottom of the vault. Use the template to drill the appropriate sized holes for the anchors you will be using. (Anchors are not included). Tranax does not recommend a particular size or type of anchor as each installation is different however maximum anchor diameter is $\frac{1}{2}$

Step 3

Install the anchors into the ground according to the anchor bolts locate sheet (4 places). See manufacturers instructions for anchor installation.

Step 4

Place the Mini-Bank ATM on top of the anchors.

Step 5

Open the Security cover with the key provided. See page 4.1 for Opening and Closing instructions.

Step 6

Using the supplied combination (factory preset at 50-25-50), open the security Door. This combination should be changed as soon as possible. Refer to page 4.5 (dial) or 4.7 (electronic) for instructions on opening or changing the lock.

Step 7

After the anchor nuts are in place, according to the anchor holes on the bottom of the Mini-Bank, secure the anchor bolts snugly. Do not over tighten anchors as it may distort the vault and cause problems with the door linkage.

END**2.1.3 HARDWARE SETUP****Step 1**

Verify the power voltage (115/220V) to be used and set the appropriate voltage on the power supply. Default will be 115V. The default setting should be 115V

**Step 2**

Verify that the telephone line to be used for the ATM is in proper working order. Tranax recommends the use of shielded (CAT5) phone line in locations with close proximity to other appliances.

Step 3

Open the security door and remove any shipping materials and note any warning or installation instructions. See page 4.1 for assistance.

Step 4

Remove the cash cassette from the box (removable cassette dispensers only). Fill the cassette or cash drawer with the appropriate amount of notes, and carefully place it in the Cash Dispensing Unit. Place the appropriate denomination label on the front of the cassette. See page 4.9 for instruction.

Step 5

Before closing the vault, thoroughly test the combination lock by locking and unlocking the lock several times. It is much easier to diagnose potential lock problems before shutting the door.

Step 6

Open the top of the ATM. Place the receipt paper in the Receipt Printer. The paper prints only on one side (shiny side) always check the roll when you install paper. Place the roll so that the coated side (shiny side) will be facing up. See page 4.12 for paper loading instruction.

Step 7

Connect the Power cable and the telephone cable to the appropriate outlets on the wall. Verify that the AC power outlet is grounded. If you are installing the illuminated topper, make sure to completely install the power cord into the A/C Out plug on the power supply. The socket takes an extra push to fully seat the plug.

Step 8

Turn the power on and verify that all systems are operational. If any part on the system or its programming is not operational, an error code will be displayed. If an error code is displayed, corrective action will be listed below it. If the error cannot be corrected, please contact your distributor. If no error code is displayed, enter the Operator Function Menu and view the Error Summary (see programming section).

END

SECTION 3: PROGRAMMING

3.1 INITIAL SETUP

3.1.1 ACCESSING THE OPERATOR FUNCTION

Step 1

To access the Operator Function menu, hold the <Cancel>, <Clear> and <Enter> keys simultaneously for 2 seconds, release them and press 1, then press 2, then press 3. The timing of this procedure can be difficult at first.

Note: The Operator Function menu can only be accessed when the machine is either in service (“swipe your card” screen) or out of service. If the machine is attempting to connect the host or initializing, you will not be able to use the key commands to access the Operator Function Menu.

If you have trouble accessing the Operator Menu, power off the ATM and then either open the vault door or remove the paper from the printer and power back on. This will force the ATM to the Operator Menu.

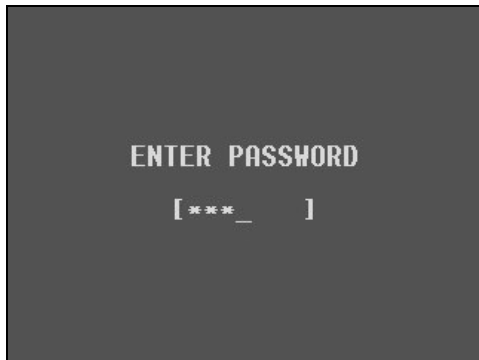

Step 2

Once you successfully completed the key combination, you will be prompted to enter a password. There are 3 options for passwords.

- Operator Password (allows access to basic menu structure)
- Service Password (allows access to basic and diagnostic menus)
- Master Password (allows access to all menus including setup parameters)

Passwords are very important to maintaining security for your ATM. Your dealer/distributor will provide you with default password information.

NOTE: Tranax Technologies, Inc. highly recommends changing your passwords from default as soon as possible. Passwords **MUST** be 6 digits in length, use of anything other than a 6 digit password may cause the passwords to revert back to factory default.

OPERATOR FUNCTION		
SETTLEMENT	NORMAL 00000	CUSTOMER SETUP
JOURNAL		SYSTEM SETUP
REPORT		HOST SETUP
DIAGNOSTICS		TRANSACTION SETUP
CANCEL TO EXIT		

Step 3

Shown the left is the complete Operator Function menu, depending on which password you entered (operators, service, master) you may not see certain functions. For example, if you use an operator password you will not see the Host Setup button, as you will not have access to that menu.

END

3.1.2 WHEN AN ERROR OCCURS



Step 1

When an error occurs, please press "CANCEL, CLEAR and ENTER" simultaneously, and then press 1, 2, 3 keys in order.

NOTE: If the machine goes out of service, the error code will not always appear on the screen. If you do not see an error code, enter operator function and go to reports. Look in the error summary for error codes.

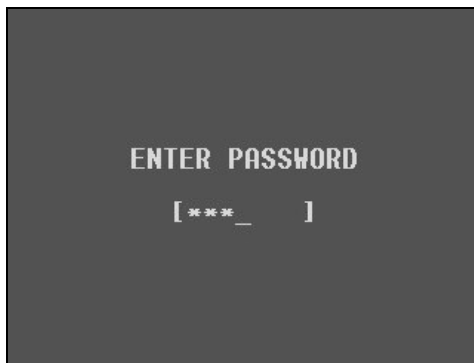

Step 2

"ENTER PASSWORD" will be displayed. Enter Master, Service or Operator Password.

Defaults:

Master = 555555

Service = 222222

Operator = 111111

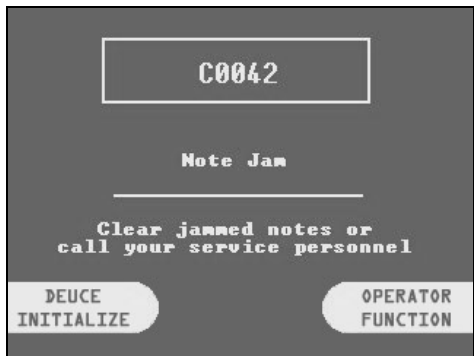

Step 3

When the screen is in current display, press "OPERATOR FUNCTION" key to access the "OPERATOR FUNCTION."

END

3.1.3 KEYPAD

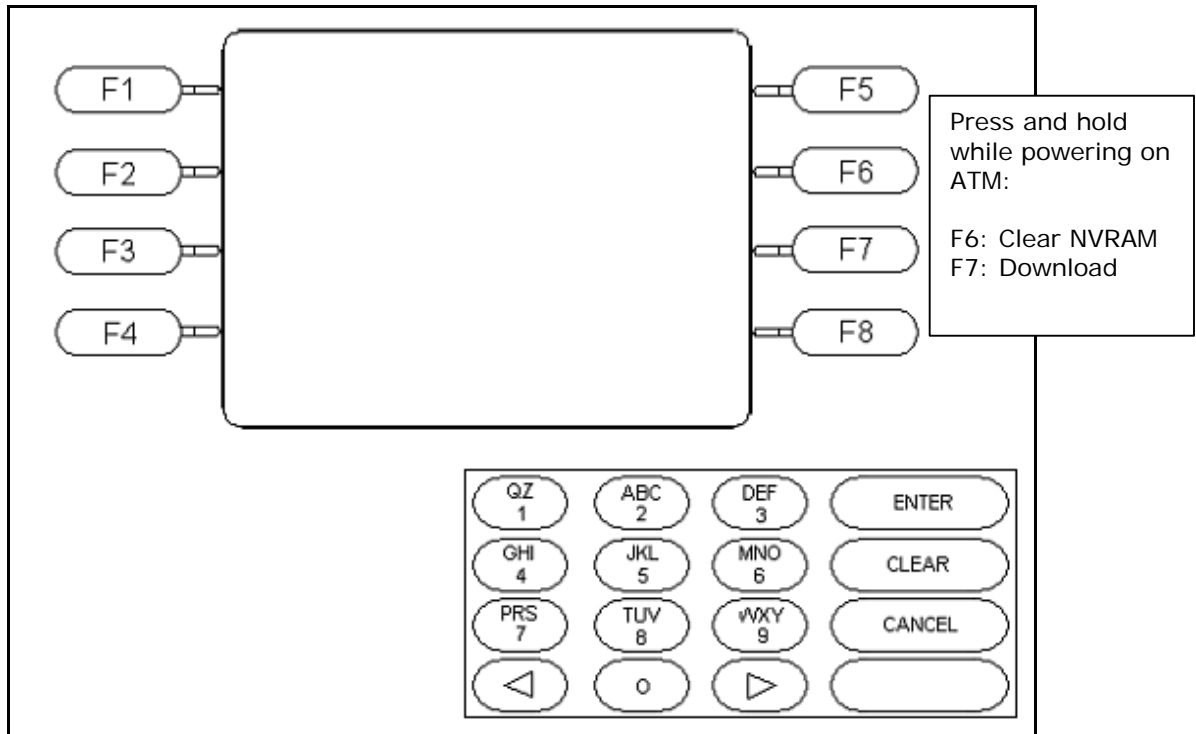

Fig. 1 Mini-Bank 1500™ keypad and LCD display

NOTE: LCD Keypads are no longer used for Master Key letters. Please see addendum included with this manual.

Shift Status			0	1	2	3	4	5	6	7	8	9
F5	Alpha	Upper	+ - =	Space Q Z	A B C	D E F	G H I	J K L	M N O	P R S	T U V	W X Y
		Lower	+ - =	Space q z	a b c	d e f	g h i	j k l	m n o	p r s	t u v	w x y
	Numeric	N/A	0 ()	1 []	2 { }	3 < >	4 , .	5 ! \$	6 ' "	7 % *	8 : ;	9 ? /
	Table	N/A	The character on the current cursor position on the screen will be selected.									

Fig. 2 Keypad Character Table

How to enter data with the keypad

1. The Keypad Character Table (Fig. 2) will appear on the bottom of the screen if keypad input is required.
2. F5 key toggles between alphabetic or numeric mode. Default is alphabetic mode.
3. F6 key toggles between upper and lowercase characters. It is valid only in alphabetic mode. Default is uppercase character.
4. The input field is defined as highlighted area.
5. In alphabetic mode, the key toggles among the characters in the given column. When key <1> is pressed once it is <SPACE>, pressed twice it is <Q>, pressed third time it is <Z>. When the desired character is selected, press <ENTER>.
6. ◀, ▶ key move the cursor position in the alphabetic or numeric mode. In the Table mode ◀, ▶ key are used to select the character.
7. <F1> key is used to clear the whole screen and returns the cursor to its initial position.
8. <F2> key is used to clear the current line.
9. <F3> key is used to ignore the changes and exit.
10. <F7> key is used to save the current changes and exit.

3.2 HOST SETUP

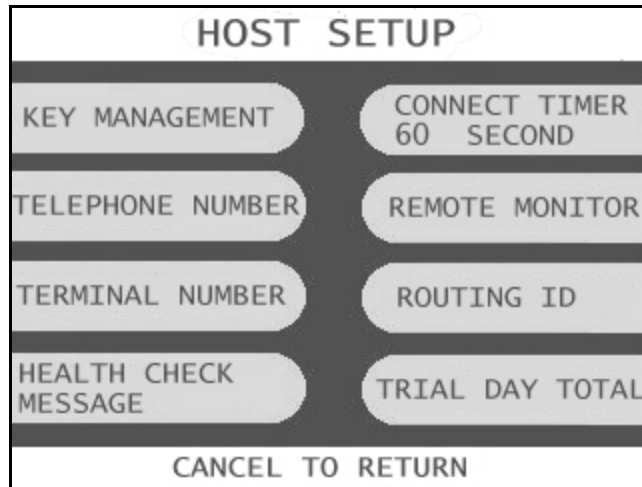

The Host Setup menu provides access to the parameters necessary to connect the ATM to the processor. Master Password is required to access most of these options; however Service password allows basic access for troubleshooting purposes.

3.2.1 KEY MANAGEMENT

Access to Key Management requires entering a "Secure Mode" which engages additional security measures (per VISA specification) to prevent Master Key tampering. Make note of these changes as it does affect how keys are entered.

Entering Key Management requires two 6-digit passwords. By default these will be "000000" for part #1 and "000000" for part #2.

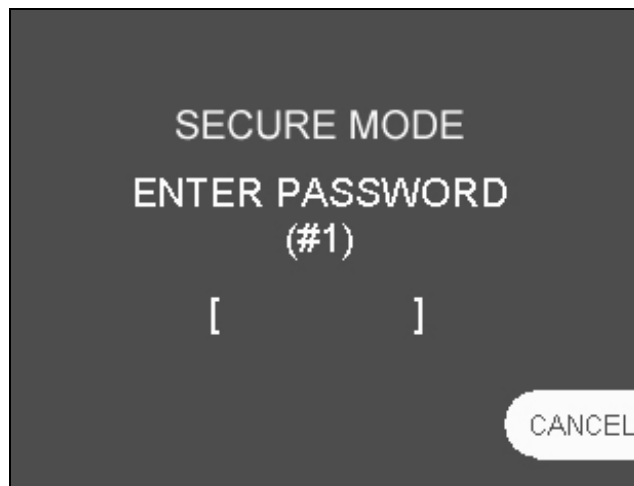

NOTE: If a mistake is made entering the "Secure Mode" password, you will be prompted to wait 30 seconds to reattempt.

Successful entry of both passwords will grant access to the Key Management screen. From the moment the Key Management area is entered, a 5 minute timer begins. At the end of 5 minutes, regardless of what you are doing (entering a master key for example) the Key Management area times out and you will be taken back to the Host Setup menu.

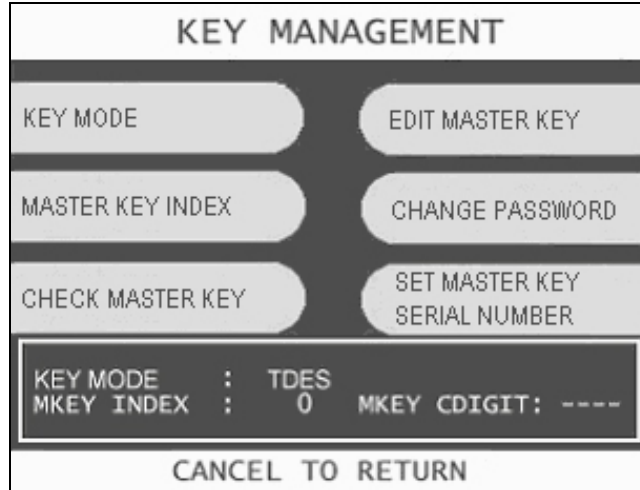

KEY MODE

This option sets the type of master key you will be loading (TDES, DES, MAC etc.) Refer to Addendum C for Key Mode descriptions and instructions.

MASTER KEY INDEX

The ATM will hold up to 16 individual Master Keys. Check with your processor to find if they are expected to be at a certain location. For example Coredata is always installed at index #9, most other processors are installed at index #0 or #1. The ATM will only use the key that the index is set to regardless of how many keys are installed. To set the index simply press the button labeled Master Key Index and then enter the number you want it set to (enter as a 2 digit number ... 00, 01, 02, 10, 11 etc.) press Enter when done. Press Check Master Key to see a list of currently installed keys.

CHECK MASTER KEY

This will show the list of available master keys and their appropriate checksums. The checksum is a 4 digit number calculated from the two 16-digit numbers of your master key that provides a means to verify the master key is correct. When your processor provides your Master Keys, they will also give you the 4 digit checksum. If after entering your Master Key this checksum does not match, try reentering your master keys or contact the processor.

EDIT MASTER KEY

This is where you enter your two 16-digit Master Keys (provided by your processor). After pressing Edit Master Key, you will be prompted to enter an index where you want this key stored. If you do not know which index to use, contact your dealer or processor.

NOTE: Because of the MiniBank 1500's Encrypted Pin Pad, you do NOT use the LCD buttons to enter the letters for the master key. Please refer to the Appendix included with the manual for entering master keys.

NOTE: Some processors only provide one 16-digit number in which case you enter all 0's or 1's for the second part. Please contact your dealer or processor for questions regarding your Master Keys.

CHANGE PASSWORD

This allows you to set each part of the "Secure Mode" Password. As with the other passwords used in the MB-1500, each must be a 6 digit number. If you change the password and cannot remember it, you must clear RAM on the pin pad to reset.

SET MASTER KEY SERIAL NUMBER

The Master Key serial number is actually the ATM serial number converted into numbers. This number is pre-programmed from the factory and should not be changed. If the memory on your ATM has been cleared and you need to program this number, do so as follows: Check the white barcode sticker on the back of the vault door for the serial number.

For example if your serial number is: Y140000012
The number you would program would be 1400000012

Entering Master Keys:

Use the chart below for entering Master Keys from the main pin pad. Master Keys (or Key Management) cannot be entered from the optional Rear Service Panel. Please see Appendix for specific Master Key instructions.

1	2	3	F
4	5	6	E
7	8	9	D
A	0	B	C



3.2.2 SET HOST TELEPHONE NUMBER

Step 1

From the Host Setup Menu, go to Telephone Number.

Step 2

You can enter a Primary (Host Phone 1) and a Secondary (Host Phone 2) for the machine to connect to the processor. This phone numbers are available from your dealer or the processor (you can also reference the quick installation guide enclosed with this ATM for numbers for the common processors).

Step 3

Once you have selected Host Phone #1 or Host Phone #2 you will be prompted with the following screen. Using the numbers on the keypad press the first number of your phone number until it is highlighted by the white box as shown below.

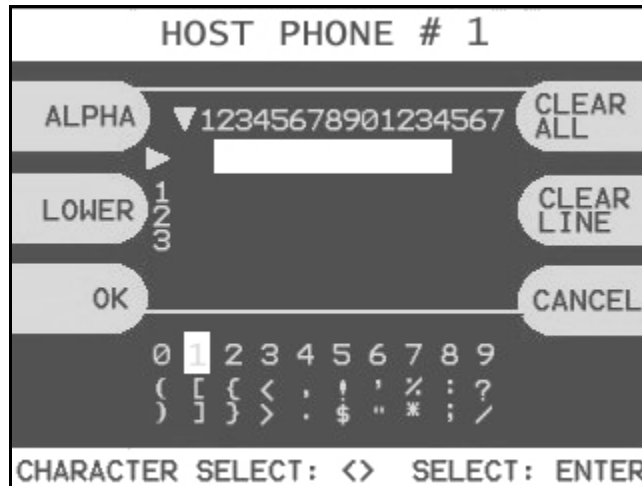

Step 4

Press Enter on the keypad to set the number. You can use the <, > keys on the keypad to move back and forth (to correct any mistakes, or edit existing numbers).

Step 5

Tranax always recommends using a dedicated, data-quality phone line for all ATM installations, however if you are using a phone line that is dialing out through a PBX type system (where you dial a number for an outside line), then you may insert commas (,) to create a pause between digits.

For example if you have to dial a 9 to get an outside line try the following:

9,,18005551212

(the 800 number being an example)

END

3.2.3 SET TERMINAL ID / ROUTING ID NUMBER

Step 1

From the Host Setup Menu, go to Terminal ID or Routing ID. Terminal ID number is provided by the processor and is individual for your ATM. It identifies your ATM on the network and any transactions done on your machine will be linked to that number. Routing ID is unique to each processor and identifies the machine by processor. Both of these numbers are obtained either through your dealer or processing company. If Host Processor Mode is set to STANDARD 3 or ST3+LYNK to use the 'extended message format' then NO Routing ID number is used.

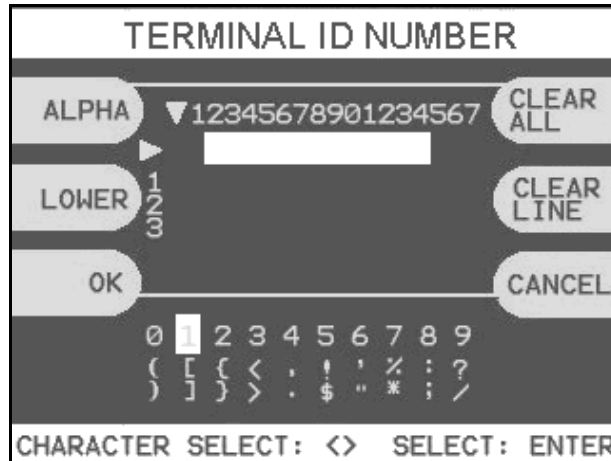

Step 2

Using the numbers on the keypad press the first number of your Terminal / Routing number until it is highlighted by the white box as shown above. If your number contains letters, press the button next to the screen labeled "Alpha", press the number on the keypad above the letter you want and press it until the correct letter is highlighted.

Step 3

Press enter after each number or letter to select it. There are 3 menus from which you can enter characters Alpha, Num, and Table. You can use the <, > keys on the keypad to move back and forth (to correct any mistakes, or edit existing numbers).

END

3.2.4 HEALTH CHECK MESSAGE

Health Check is an option that will send a system status signal to your processor at a set interval. Check with your dealer or processor to determine if they are prepared to receive this type of messaging.

To enable simply access the menu from Host Setup. Use the Host Send button to enable or disable the feature and the Message Send Interval button to set how often the machine will broadcast its status (in hours).

NOTE: If Host Processor Mode is set to STANDARD 3 or ST3+LYNK to use the 'extended message format' then Health Check must be DISABLED!

3.2.5 CONNECT TIMER

The connect timer is the setting which determines how long the machine will wait to connect when trying to dial into the processor. Default time is 60 seconds. Lowering this may improve connection speeds but at the risk of reliability.

3.2.6 REMOTE MONITOR

Remote Monitoring is the ability to dial into your ATM and send or retrieve information using Tranax Remote Management Software (RMS).

REMOTE MONITOR	
RMS EN/DISABLE	REMOTE PHONE #1
RMS STATUS SEND EN/DISABLE	REMOTE PHONE #2
PASSWORD	MODEM SPEED
RMS, RMS SEND : ENABLE, DISABLE PASSWORD : 0137 MODEM SPEED : 56000	
CANCEL TO RETURN	

RMS EN/DISABLE

This will allow the ATM to be monitored remotely.

Enable The ATM will answer incoming RMS calls.
 Disable The ATM will not answer any incoming calls.

RMS STATUS SEND

This feature causes the ATM to dial out to a computer running RMS software to report a malfunction, a fatal error or an out of service condition. Any time the ATM goes out of service for longer than 3 minutes, it will call the number programmed at Remote Phone #1 (and then Remote Phone #2 if Remote #1 is busy). It will attempt this call 3 times. In order to use this feature you MUST have a PC (with a modem and a dedicated phone line) running RMS software available 24 hours a day.

Enable The ATM will dial out to report out of service condition.
 Disable The ATM will NOT dial out to report out of service condition.

RMS PASSWORD

Remote monitoring is protected by a password that is checked when incoming calls from RMS occur. If the password does not match from an incoming RMS call, the call will be disconnected. The default password for RMS access is 333333 (checksum= 0137). To change the password, press the password button and you will be prompted to enter your Master password. After entering your Master password, you will be prompted to enter the new RMS password (must be 6 digits) and then enter it again for verification. If you ever forget the RMS password, press password and follow the procedure again.

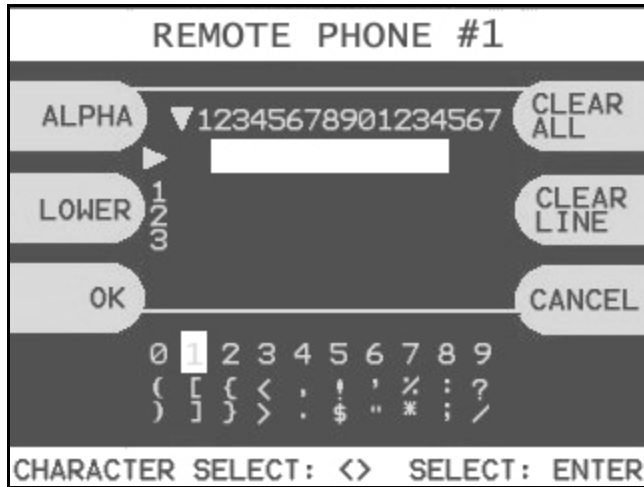
REMOTE PHONE #1, #2

This is the number the ATM will call if there is an out of service condition. Press the button for either number and enter the number for the computer you want the ATM to call.

Using the numbers on the keypad press the first number of your phone number until it is highlighted by the white box as shown above. Press Enter on the keypad to set the number. You can use the <, > keys on the keypad to move back and forth (to correct any mistakes, or edit existing numbers).

MODEM SPEED

This setting is used to match the modem of the ATM to the PC that will be interacting with it through RMS. If your PC uses a 28.8 modem, you may speed connection time by lowering the RMS modem speed to 19200. This may only be necessary for extreme cases or situations where connection is not possible due to poor quality phone lines. If you are unable to connect to the ATM with your PC try lowering the speed to 1200 or 2400 and then move up from there. Press the Modem speed button to toggle the choices. Available speeds are 300, 1200, 2400, 4800, 9600, 19200, 38400, 56000.

3.2.7 TRIAL DAY TOTAL

Trial Day Total feature allows the ATM to complete a Day Total operation (without actually closing out the machine) at a predetermined time each day. This is useful if you are doing accounting of your ATM on a day-to-day basis. Your processor cuts off its transactions each day at a set time. By enabling Trial Day Total at the same time, your day's balance should match the host. This information will appear as a journal record, so you will need to access your journal to print or view the totals. Your dealer or processor can provide you with the appropriate cut off time.

Trial Day Total	Enables or Disables the function
Set Logging Time	Sets the time for the ATM to total itself

3.2.8 HOST PROCESSOR MODE

Host Processor selection changes the communications protocol to specifically match your particular processor. In most cases this is set at the factory when your machine is ordered, however in the event that the machine needs to be reprogrammed for a new processor, it may be necessary to change the processor mode.

NOTE: The Processor selection menu requires a special procedure to access, and will require you to clear out the memory on the ATM to access. This means all existing journal and programming to be lost.

To access the Host Processor mode, begin by clearing NVRAM.

Power off the ATM and hold down button **[F6]** as shown on page 3.4, power the machine back on while continuing to hold the button down.

You'll be prompted with a screen asking if you want to "CLEAR NVRAM" press yes. You then be prompted to enter the master password. If you do not successfully enter the correct master password after 3 attempts it will abort the action.

Once the memory is cleared, the ATM will reboot and immediately go out of service (since the programming has been cleared). At this point all passwords have reverted to factory default, so enter the operator function menu using the "55555" default.

Go to the Customer Setup menu, and press the **[F8]** button as shown on page 3.4, (there will not be a corresponding button on the screen) this will access the processor mode selection menu.

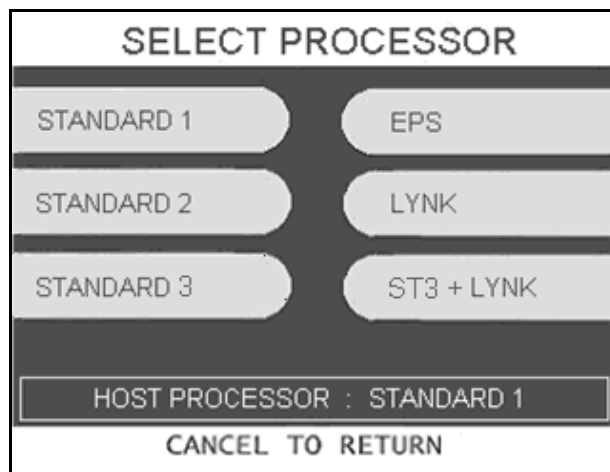

Once the processor mode has been selected, it will appear in the box at the bottom of the screen. Once this menu has been exited, if you wish to enter it or change processor mode again, you'll have to clear NVRAM and start over.

Contact your distributor or processor for which mode is appropriate.

3.3 THE SYSTEM SETUP MENU

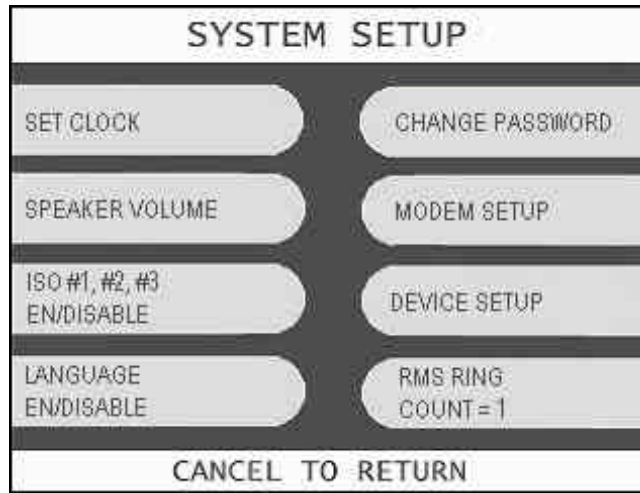

3.3.1 SET CLOCK

The Set Clock menu allows you to set the clock built into the ATM to the appropriate date and time. You should set this for local time in the area the machine is to be installed. Note that with each transaction you will also see a "Host" time, this is the local time for the processor and may be different from local time at the ATM. To set the clock, simply press the Set Clock button and press the key corresponding to the function you want to set (month, day, year, etc.)

NOTE: The ATM will not automatically adjust for daylight savings time. You must set this manually if you wish it to change.

3.3.3 ISO 1, 2, 3 EN/DISABLE

The ISO Tracks are the three tracks available for the card swipe head to read. The ATM is defaulted to only read from Track #2. This parameter should not be changed. Changing the ISO tracks can cause the ATM to not read cards properly.

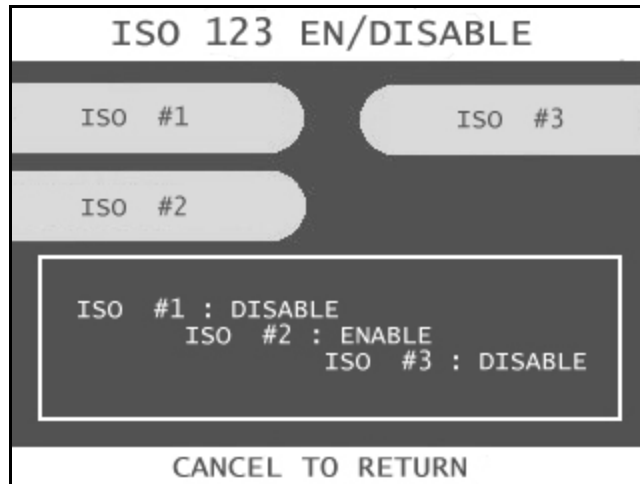

3.3.4 OPTIONAL LANGUAGES

The MiniBank 1500 ATM supports 5 on screen languages: English, French, Spanish, Korean and Japanese. The optional languages will display on the welcome screen, then the customer will be prompted to choose a language to be used for the rest of that transaction.

NOTE: The optional languages are displayed on screen only and do not print on the receipt or journal. Receipts, journals and operator menus are always in English. To enable or disable a language, simply press the button next to the language you wish to change.

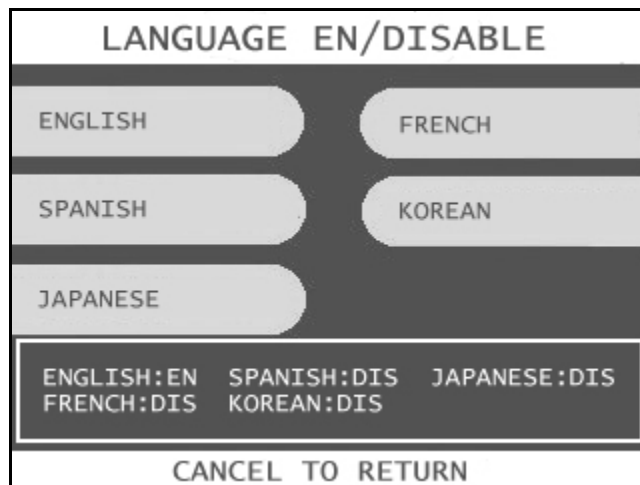

3.3.5 CHANGE PASSWORDS

The ATM uses three passwords to provide security to the operator menu system. These are Operator, Service and Master.

- Operator Password (allows access to basic menu structure)
- Service Password (allows access to basic and diagnostic menus)
- Master Password (allows access to all menus including setup parameters)

The operator password can be changed by anyone with the current operator password. The service and operator passwords can be changed by anyone with the service password. The master password can only be changed by someone with the current master password. Any password can be changed using the master password.

For example, if you have lost the operator or service password, you can use your master password to change them. Simply enter the master password when it requests the operator or service password and then enter the new password.

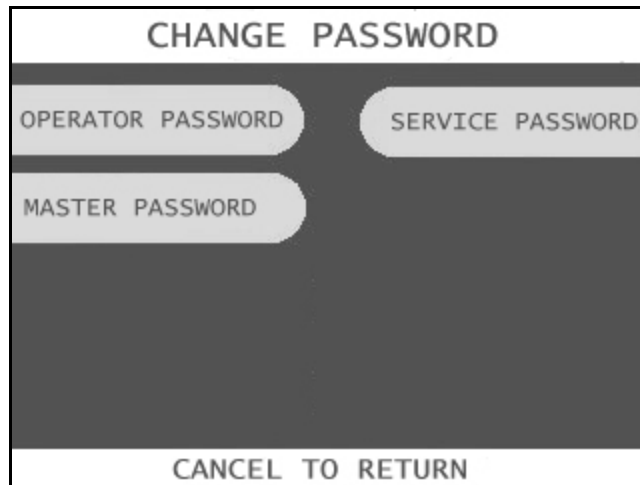

To change a password, press the button for the appropriate password and you will be prompted to enter the "current" password. After entering the current password you will be prompted to enter the new password and then enter it a second time to verify. If you forget your password please contact your dealer or distributor for service.

WARNING: All passwords MUST be 6 digits. If you use a password that is less than 6 digits, the passwords may default back to factory if the machine is power cycled. If your customer wants a 4 or 5 digit password, add zeros to the end to make it 6 digits.

3.3.6 MODEM SETUP

The MiniBank 1500 series use an onboard 56K modem. The modem is preset at the factory for optimal use. Changing these settings can cause your machine to not communicate or may slow communication speeds. Do not make changes to the modem settings.

MODEM SETUP	
DIAL MODE	SPEAKER OUT
MODEM SPEED	INITIAL STRING
DIAL MODE : DTMF MODEM SPEED : 2400 SPEAKER OUT : OFF INITIAL STRING : AT&F&Q6+MS=2	
CANCEL TO RETURN	

DIAL MODE

This selects between tone dialing and pulse dialing. (tone dialing recommended)

DTMF = Tone dialing
 PULSE = Pulse dialing

MODEM SPEED

This sets the speed at which the modem will begin communication with the host. The default speed is 2400. Most processors are only using 2400 baud modems, so setting this value higher may not increase modem performance.

Available settings : 300, 1200, 2400, 4800, 9600, 19200, 38400, 56000

SPEAKER OUT

This will allow the modem to output its dial-out and handshaking through the external speaker. This is useful when testing the modem to hear if it's dialing properly.

Available setting: OFF , ON

INITIAL STRING

This is the command line that the modem uses to communicate. This should not be changed from factory default. Changing the modem string can cause communications problems.

Factory Init String for Mini-Bank 1500™ = AT&F&Q6+MS=V22B

3.2.7 MODEM TEST

This is a built in self-test for the modem circuit. To perform the test, simply press the modem test button and you will receive a response back from the modem. Below shows the appropriate response for a good modem. Press Enter to return to menu.



3.2.8 RMS RING COUNT

RMS Ring count will set the number of rings before the ATM will answer the phone. This option is useful if you are sharing the phone line with a fax or other device, which needs to answer the phone. The downside to this is if something else is answering then the Remote Management Software (RMS) will not be able to connect unless that device is turned off. Tranax does not recommend setting this count higher than 4 rings if you intend on connecting with RMS.

To change the count, press the RMS Ring Count button and then enter a number(s) from the main keypad.

3.4 CUSTOMER SETUP MENU

The Customer Setup menu controls surcharge information, BIN lists, receipt options, advertisements and keypad lighting.

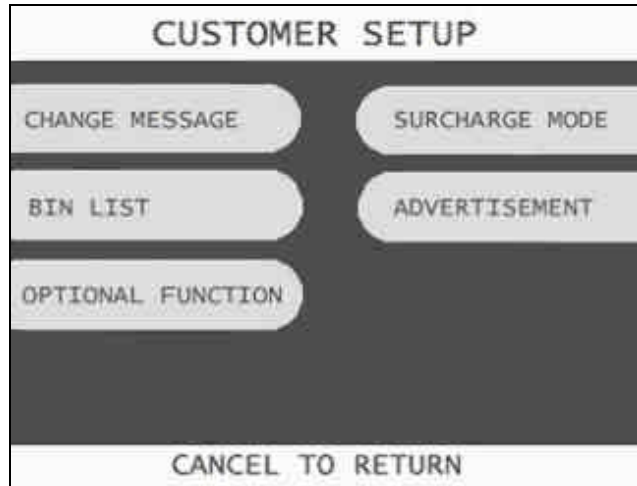

3.4.1 CHANGE MESSAGE

The Messaging options for the ATM are a welcome message and a receipt header message. The welcome message allows up to 4 lines of 25 characters, which will appear above the "Swipe Your Card" message on the opening screen. The receipt header is up to 4 lines of 25 characters, which will appear at the top of each receipt.



WELCOME MESSAGE

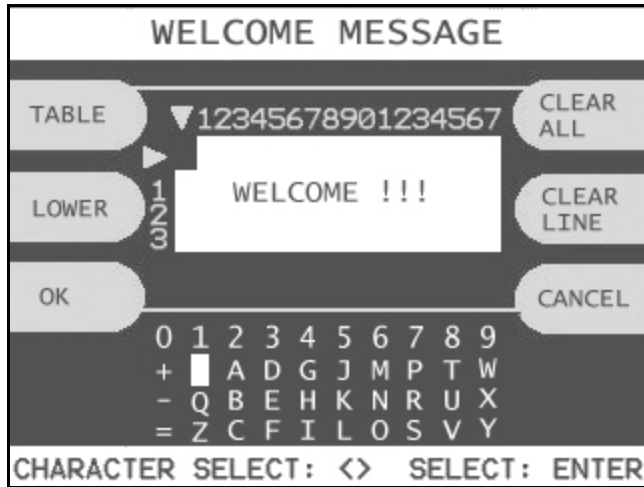

Once you have selected Welcome Message from the Change Message Menu, you will be prompted with the following screen.

Using the numbers on the keypad press the number above the letter you wish to select until that letter is highlighted by the white box. Press Enter on the keypad to set the letter. Use the <, > keys on the keypad to move back and forth (to correct any mistakes, or edit existing messages).

There are 3 tables to choose characters from:

- NUM = Numbers and punctuation marks
- ALPHA = Letters, an empty space and +, -, =
- TABLE = All characters, upper and lower case letters and number.

RECEIPT HEADER

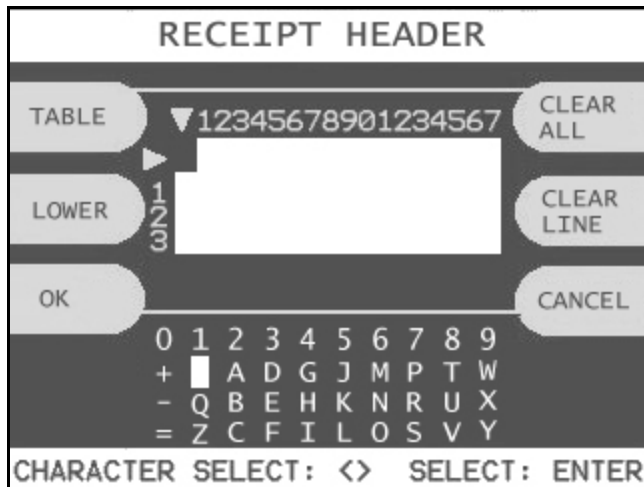

Once you have selected Receipt Header from the Change Message Menu, you will be prompted with the following screen. See the above instructions for navigating this menu.

3.4.2 BIN LISTS

BIN numbers are card numbers that you have preset with your processor to not be surcharged. You must set this up with your processor, who will then give you numbers to enter in the list. These numbers will reference cards that you wish to not be charged a surcharge for transactions. The ATM will hold up to 96 numbers (0-95).

The screenshot shows a menu titled "BIN LIST" with a checkmark icon. It contains eight buttons labeled "BIN LIST 1" through "BIN LIST 8" arranged in two columns. At the bottom, there is a button labeled "CANCEL TO RETURN".

Step 1

To enter the BIN numbers select BIN List from the Customer Setup menu. The 96 numbers are divided into 8 banks of 12 numbers.

The screenshot shows a screen titled "BIN LIST 1" with a checkmark icon. At the top, there are two buttons: "ENTER INDEX" and "EDIT BIN LIST". Below these is a section titled "BIN LIST INDEX = 0" containing a list of indices from 0 to 11, each preceded by "#(". The list is arranged in two columns. At the bottom, there is a button labeled "CANCEL TO RETURN".

Step 2

Next, select a bank to proceed to the edit screen (begin with BIN LIST 1).

Step 3

Select an index to enter a number, press Enter Index and type in the index you wish to edit (starting with 0). Next, press Edit Bin List and enter the BIN number. Use the numbers on the keypad and press the first number of your BIN number until it is highlighted by the white box. Press Enter on the keypad to set the number. You can use the <, > keys on the keypad to move back and forth (to correct any mistakes, or edit existing numbers). Press Ok when finished.

END

3.4.3 OPTIONAL FEATURES

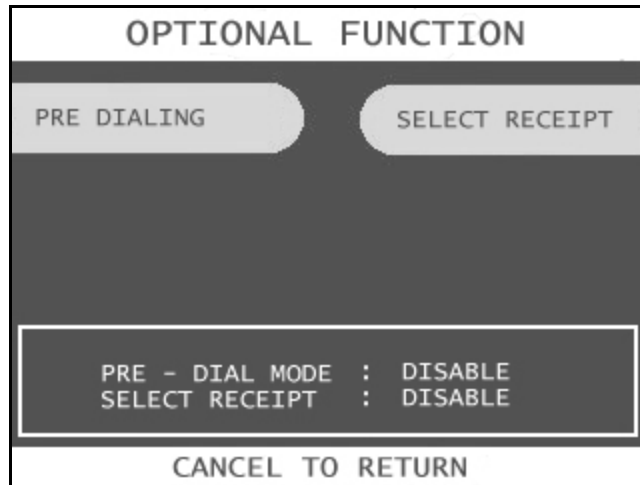

The ATM offers 2 optional functions to improve performance and keep the ATM functional in the event of a paper problem (jam, out of paper etc.) These are Pre-dialing and Selective Receipt.

PRE-DIALING

With this feature enabled the ATM will begin to dial out to the processor as soon as a customer swipes their card. This will save considerable time for each transaction. With the option disabled, the ATM will begin dialing after the customer has chosen a transaction type and selected an amount.

To enable this feature, choose Optional Function from the Customer Setup Menu. Next select Pre Dialing, the lower portion of the screen will display if the option is enabled or disabled.

SELECT RECEIPT

This feature allows the ATM to complete transactions even though it may not be able to dispense a receipt. If the ATM experiences a paper jam, or runs out of paper, the customer will be asked if they would like to complete the transaction even though they will not receive a receipt. If the customer answers Yes, the transaction will continue. Following the transaction the customer's information (what would have appeared on the receipt) will display on the screen. The ATM will continue to operate without use of the printer until someone accesses the Operator Function menu. At that time the error must be corrected before the ATM will go back into service.

To enable the option, press Select Receipt, the lower portion of the screen will display the options status.

3.4.5 SURCHARGE MODE

The Surcharge menu displays the current rate at which customers are charged per transaction, the person or account that the surcharge funds are sent to and whether or not the option to surcharge is enabled or disabled. The information programmed here must match the information given to the processor at the time the account was created. When the ATM dials into the processor for any reason, it compares the information the processor has on file with what is programmed in this section. If there is a discrepancy, the ATM will automatically update its surcharge information based on the processors records. For example: If your ATM is set with the processor to charge \$1.50 per transaction and you manually enter \$2.00 into the surcharge amount, as soon as the machine connects to the processor it will revert back to \$1.50. You must contact the processor if you wish to make changes to the surcharge information.

SURCHARGE MODE

DISABLE SURCHARGE OWNER

AMOUNT

SURCHARGE MODE : ENABLE
 SURCHARGE OWNER :
 SURCHARGE AMOUNT : \$1.00

CANCEL TO RETURN

To set the surcharge parameters begin by entering the Surcharge Mode menu from the Customer Setup menu. The bottom of the screen displays the current status of each surcharge parameter.

DISABLE/ENABLE

This button toggles the surcharge option on and off.

AMOUNT

To set the surcharge amount, press the amount button and type the dollar amount using the main keypad. Next set the decimal point using the Enter key on the keypad. Then type the cents using the keypad and finally press Enter to finish.

Example: To set surcharge amount at \$1.50, press Amount, then "1", then Enter, then "5", "0" and Enter again to finish.

SURCHARGE OWNER

The screenshot shows a terminal-style interface for setting a surcharge owner. At the top, the title 'SURCHARGE OWNER' is displayed. Below it, there are three rows of buttons: 'ALPHA' (with a dropdown arrow and a character table '12345678901234567'), 'LOWER' (with a vertical list '1', '2', '3'), and 'OK'. To the right of these buttons are 'CLEAR ALL', 'CLEAR LINE', and 'CANCEL'. Below the buttons is a numeric keypad with digits 0-9 and symbols: (, [, {, <, ., !, ', %, :, ?. A white box highlights the '1' key. At the bottom, a status bar reads 'CHARACTER SELECT: <> SELECT: ENTER'.

The surcharge owner can be up to 25 characters long. This owner name will appear at the bottom of each transaction receipt. To enter the surcharge name press the surcharge owner button and then select a character table by pressing the button labeled ALPHA.

There are 3 tables to choose characters from:

NUM = Numbers and punctuation marks

ALPHA = Letters, an empty space and +, -, =

TABLE = All characters, upper and lower case letters and number.

Using the numbers on the keypad press the number above the letter you wish to select until that letter is highlighted by the white box. Press Enter on the keypad to set the letter. Use the <, > keys on the keypad to move back and forth (to correct any mistakes, or edit existing messages). The above diagram shows the surcharge owner screen.

3.4.6 ADVERTISEMENTS

The Mini-Bank 1500™ is capable of displaying up to 7 graphic screen advertisements. These ads are created on a computer and then downloaded into the ATM either directly at the ATM using a laptop and a special download cable (available from your dealer) or through the phone line using the Remote Management Software (RMS). When the advertisements are injected and enabled they will rotate in order while the ATM is waiting for a transaction and also while the transaction is processing. There is a timer, which allows you to set a delay before switching to the next graphic screen. Please see Appendix D at the end of this manual for detailed instructions for creating advertisements.

RECEIPT COUPONS



The ATM can print up to 4 coupons as a trailer to each transaction receipt. Each coupon can be up to 2 lines of text, 25 characters per line. Each coupon is surrounded by a border at the end of the receipt and looks like the following.

Above each coupon will also print the date and time, the Terminal ID, a Journal Sequence number and unique reference number made up of the date and sequence number.

The purpose of this is to allow tracking and authenticity of coupons if a value is attached to them.

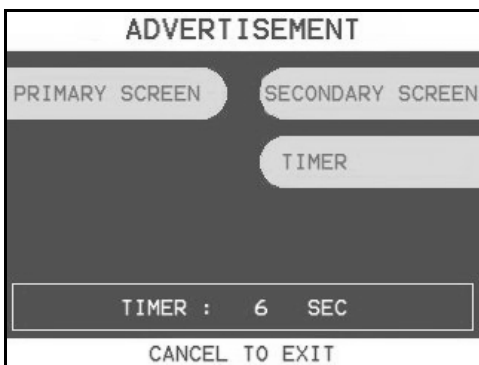

Step 1

To create a receipt coupon go to Customer Setup Menu, then Advertisement.

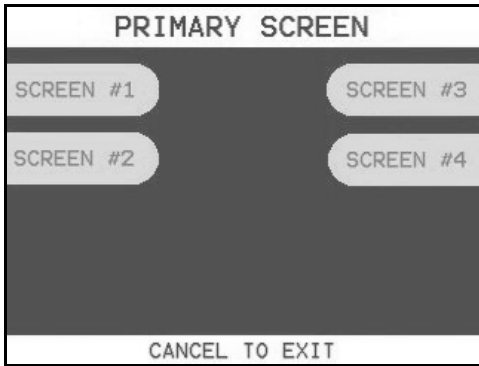

Step 2

Next choose Primary Screen, this will give you the option of 4 screens, each of these primary screens can have a coupon. **NOTE:** The coupons are completely independent of on screen advertisements or whether or not they are enabled or disabled.

Choose any of the 4 primary screens to create the coupon.

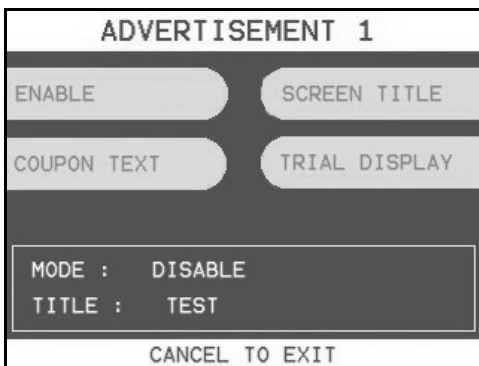

Step 3

Press the button for Coupon Text to create the coupon. **NOTE:** The Mode displayed at the bottom of the screen is for the on screen advertisement and will not effect the coupon.

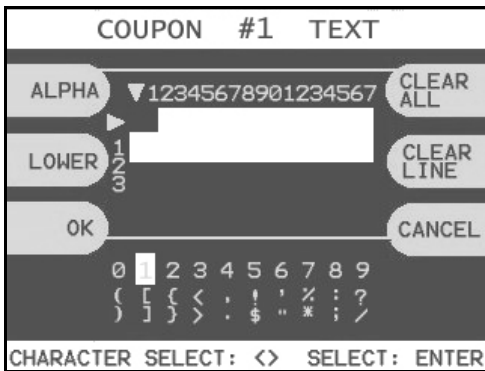

Step 4

Using the numbers on the keypad press the number above the letter you wish to select until that letter is highlighted by the white box. Press Enter on the keypad to set the letter. Use the <, > keys on the keypad to move back and forth (to correct any mistakes, or edit existing messages).

There are 3 tables to choose characters from:
 NUM = Numbers and punctuation marks
 ALPHA = Letters, an empty space and +, -, =
 TABLE = All characters, upper and lower case letters and number.

END

3.5 TRANSACTION SETUP

TRANSACTION SETUP	
DISPENSE LIMIT	DISPENSE LIMIT > \$100
DENOMINATION	DENOMINATION > \$ 10 , \$ 20
FAST CASH	FAST CASH 20, 40, 60, 80, 100, 0
CURRENCY LOW CHECK	LOW CURRENCY CHECK > DISABLE
CANCEL TO RETURN	

3.5.1 DISPENSE LIMIT

The dispense limit is the maximum amount of money a customer can withdraw in a single transaction. The ATM will dispense a maximum of 40 notes per transaction. So the dispense limit can be a maximum of 40 times the denomination of notes your using.

For example:

If you are dispensing \$10 bills the maximum dispense limit is \$250
 If you are dispensing \$20 bills the maximum dispense limit is \$500
 Maximum is \$900 (using \$50 or \$100 bills)

To set the dispense limit, press the Dispense limit button and then enter the number using the keys on the main keypad. Press Enter key to set the value.

3.5.2 DENOMINATION

SELECT DENOMINATION	
FIRST CST DENOMINATION	SECOND CST DENOMINATION
NON-CASH	
FIRST CST : \$ 10 SECOND CST : \$ 20	
CANCEL TO RETURN	

The Denomination is the type of bill that each cassette will be dispensing. The ATM offers a second cassette as an option. This second cassette can be programmed to dispense notes, it can also dispense a preset number of bill sized coupons with each transaction and finally it can dispense a "value coupon", where you would set the value of the coupon and the customer could purchase this using their card.

To set denomination on the first cassette, press the First CST Denomination button and then using the main keypad enter the type of bill. Options are \$1, \$5, \$10, \$50 and \$100.

To set denomination on the second cassette, press the Second CST Denomination button and then using the main keypad enter the type of bill. Options are \$0, \$1, \$5, \$10, \$50 and \$100.

NOTE: The Non-Cash button shown above will not appear unless the second cassette denomination is set to \$0.00

SET NON-CASH

The screenshot shows the 'SET NON-CASH' menu. At the top, the title 'SET NON-CASH' is displayed. Below the title are two buttons: 'TYPE OF NON-CASH' and 'VALUE OF NON-CASH'. Below these buttons is a button labeled 'Free Coupon / Tr.'. A summary box displays the following information:

Type of Non-Cash	:	
Value of Non-Cash	:	\$ 0.00
Free Coupon / Tr.	:	1

At the bottom of the screen is a button labeled 'CANCEL TO RETURN'.

When you set the second cassette denomination to \$0 you will have access to the Set Non-Cash menu. This menu will allow you to set the type of non-cash item to be dispensed from the second cassette.

TYPE OF NON-CASH

If you are going to be selling a non-cash item (for example: a voucher for stamps). This is where you will set the name of the item to be sold. The text you enter for this will appear as an option to the customer after they swipe their card and enter the PIN. To set the type of non-cash coupon, press the button and enter the name into the screen shown to the left.

Select a character table by pressing the button labeled ALPHA. Using the numbers on the keypad press the number above the letter you wish to select until that letter is highlighted by the white box. Press Enter on the keypad to set the letter. Use the <, > keys on the keypad to move back and forth (to correct any mistakes, or edit existing messages).

VALUE OF NON-CASH

This sets the value for the non-cash item to be dispensed from the second cassette. For example, if you were going to be dispensing a voucher for a \$5 book of stamps, you would set the value to \$5.00. When the customer using the ATM chooses to purchase stamps, they will then see a menu offering stamps at 1 for \$5.00, 2 for \$10.00, 3 for \$15.00 and so on.

To set the value of non-cash, press the button and enter the amount from the main keypad, use the Enter key for the decimal "." and then press Enter when completed.

FREE COUPON/TR.

This allows you to dispense free coupons with each transaction. If you set the value of non-cash to \$0.00, you can specify a number (1-25) of coupons to dispense. To set this amount, press the Free Coupon / Tr. button and then enter the amount from the main keypad. Press Enter when finished.

3.5.3 FAST CASH

Fast Cash amounts are presented to the customer if they choose a Withdrawal transaction. These amounts appear on screen as an easy method of selecting how much cash they wish to withdraw for that transaction. The amounts must be multipliers of the denomination amount.

For Example:

If your dispensing \$10 bills then you can use \$10, \$20, \$30, \$40, \$50 etc.
If your dispensing \$20 bills then you can use \$20, \$40, \$60, \$80, \$100 etc.

To set the fast cash amounts, select Fast cash from the Transaction Setup menu and then choose from the 6 possible keys to program. Select a button (see screen below) and then enter the value from the main keypad. Press Enter to confirm the setting.

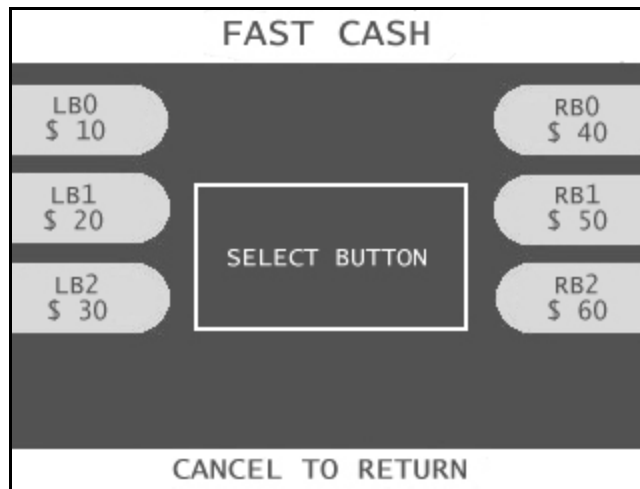

3.5.4 LOW CURRENCY CHECK

The ATM uses a digital sensor in the cash dispenser to determine when the amount of bills in the cassette reaches a certain point. This is not adjustable and will vary depending on whether or not you use new bills or used bills. Generally speaking this warning will occur at between 50 and 75 bills. So when the cash count drops to that point the machine will go out of service and prompt you to replenish the cassette.

To enable this feature, simply press the Currency Low Check button. The status of the sensor is displayed in the window to the right of the button.

NOTE: If you are not maintaining at least 100 notes in your cassette, we do not recommend enabling this option. This option is more ideal for locations where the cassette is filled each time cash is loaded.

Low currency check is not available with the 1000 note (cassette) dispenser. The drawer type, 2000 and 4000 note dispensers will support this function.

SECTION 4: OPERATION

4.1 OPENING AND CLOSING

4.1.1 Opening the Security Door



Step 1

Turn the Security Cover key clockwise to open the Security Cover.



Step 2

To unlock the Combination Lock, refer to Section 4.1.6.



Step 3

Turn the security Door Handle counter-clockwise; then pull the security door to open.

END

4.1.3 Closing the Security Door



Step 1

With the security door handle turned counter-clockwise, close the security door and turn the security door handle clockwise until it is locked. Make sure one more time that the security door is closed. NOTE: The handle must be completely vertical before turning the lock. Failure to do so may allow the door to remain unlocked.



Step 2

Turn dial to the LEFT at least four full revolutions.



Step 3

With the security cover key turned clockwise, close the security cover and turn the security cover key counter-clockwise until locked. Remove the key when it is locked.

END

4.1.4 Opening the Front Panel

**Step 1**

Insert the Front Panel key and turn it clockwise.

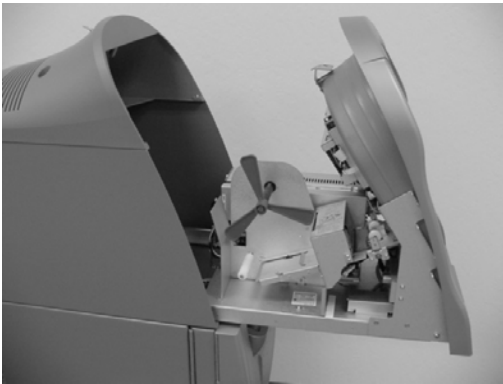
**Step 2**

With the Front Panel key turned, pull the Front Panel outward.

END

4.1.5 Closing the Front Panel

**Step 1**

Push the Front Panel slowly until it is locked back in place.

**Step 2**

Turn the Front Panel key counter-clockwise until the Front Panel key can be taken out.

END

4.1.6 Operating and Changing the Combination Lock (non-electronic)

Before operating the lock or changing the combination, READ THESE INSTRUCTIONS THOROUGHLY.

At the top of the dial ring, an index is provided for normal dialing and opening. At the side of the opening index (11 o'clock), a changing index is provided for use only when setting a new combination.

This is a precision lock; therefore, extreme care must be used to align the combination number with the index.

Turn the dial slowly and steadily. If after turning the correct number of revolutions, any number is turned beyond the index, the entire series of combination numbers must be re-dialed. **DO NOT TURN BACK TO REGAIN A PROPER ALIGNMENT WITH THE NUMBERS.** Each time a selected number is aligned with the opening index, a revolution is counted.



TO UNLOCK ON A FACTORY SETTING - For Example "50-25-50"

Step 1

Turn the dial to the LEFT, stopping when "50" is aligned with the opening index, the FOURTH time.

Step 2

Turn the dial to the RIGHT, stopping when "25" is aligned with the opening index, the THIRD time.

Step 3

Turn the dial to the LEFT, stopping when "50" is aligned with the opening index, the SECOND time.

Step 4

Turn the dial slowly to the RIGHT until the bolt retracts.

END

TO LOCK

Turn dial to the LEFT at least four full revolutions.

END

CAUTION: Before closing the unit, try the new combination several times using the opening index.

Changing to a New Combination

To make up a new combination, select 3 sets of numbers of your own choosing.

- DO NOT USE NUMBERS BETWEEN 0 AND 20 FOR YOUR LAST NUMBER
- DO NOT USE NUMBERS ENDING IN 0 OR 5
- DO NOT USE NUMBERS IN A RISING OR FALLING SEQUENCE (e.g. 35-50-75)

Insert Figures (3)

Step 1

Using the changing index, dial the existing combination as explained in paragraphs 1-3 above.

Step 2

Hold the dial with the last number at the changing index and insert the changing key in the keyhole in the back of the lock. Insert the key until the wing is entirely inside the lock and comes to a positive stop.

Step 3

Turn the key one-quarter turn to the RIGHT or "clockwise". With the changing key in this position, turn the dial to the LEFT; stopping when the first number of the newly selected combination aligns with the changing index the FOURTH time.

Step 4

Turn the dial to the RIGHT, stopping when the second number is aligned with the changing index, the THIRD time.

Step 5

Turn the dial to the LEFT, stopping when the third number is aligned with the changing index, the SECOND time. Holding the dial in this position, turn the changing key back to the LEFT or "counter-clockwise" and remove it. The new combination you have chosen is now set in the lock.

END

WARNING: NEVER INSERT THE CHANGING KEY IN THE LOCK WHEN THE COVER IS REMOVED. ALWAYS BE CERTAIN THAT THE WING OF THE CHANGING KEY IS ENTIRELY WITHIN THE LOCK BEFORE TURNING THE KEY. IF AN ERROR HAS BEEN MADE IN SETTING A NEW COMBINATION, WE SUGGEST THAT AN ACCREDITED LOCKSMITH BE CONTACTED.

4.1.7 Operating and Changing the Electronic Lock

Before operating the lock or changing the combination, READ THE INSTRUCTIONS THOROUGHLY*.

***See manufacturers lock manual included in the “Open Me First Box”**

The LA GARD “LG Basic” series electronic lock uses a touch key pad for all lock functions.

Power is supplied to the lock via a standard 9-volt Alkaline battery which contained within the external portion of the lock. The lock will warn of low voltage by repeatedly beeping.



TO UNLOCK FROM DEFAULT COMBINATION – (1-2-3-4-5-6)

Step 1

Press the default combination one button at a time, 1, 2, 3, 4, 5, 6. A beep is heard following each key press.

Step 2

If the combination is entered correctly a double-beep is heard and the internal lock solenoid will click indicating that the lock is open and the vault handle may now turn.

Step 3

If the wrong combination is entered a triple-beep will be heard. If the correct combination is not entered within 4 consecutive attempts a 5 minute delay or “lock out” will begin. During this time, the led at the 2 o’clock position on the face of the lock will flash at 10 second intervals. In addition any key press will respond with a triple-beep. Once the 5 minutes has elapsed, 2 more consecutive failed attempts will restart the 5 minute timer.

END

WARNING: While orienting yourself with the lock, making changes to the lock programming (including changing the combination) ALWAYS work with the vault door open. Do not close the vault until the lock has been thoroughly tested.

Tranax does NOT program a master combination!

Changing to a New Combination

NOTE: Combination is required to be 6 digits. Combinations of less than 6 digits will not work.

Step 1

Begin by entering six zeros. (000000)

Step 2

Enter the existing combination one time (default = 123456)

Step 3

Enter the new combination twice. As each six digit sequence is entered, a beep is heard.

Step 4

If the procedure is not performed correctly, at the end a triple-beep is heard and the lock will revert back to the previous combination.

END

The LG Basic series lock includes several options including multiple user / manager passwords. Please consult the LA Gard manual included in the "Open Me First" box for instructions.

4.2 CASH OPERATIONS

4.2.1 Adding Cash to the Cassette



Step 1

Open the Security Door. (Please see 4.1.1.1 OPENING/CLOSING THE SECURITY DOOR.)



Step 2

With one hand holding the Cash Cassette handle press the green unlocking latch and pull the cassette drawer out carefully.

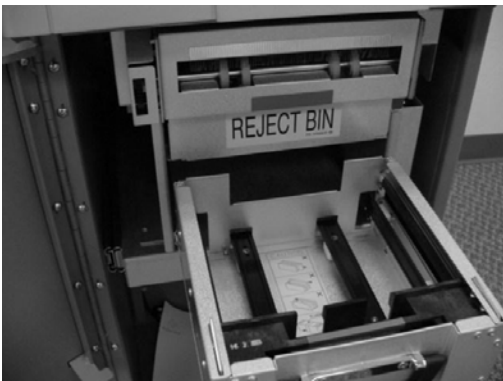

Step 3

Pull the cash plate back until it locks.

**Step 4**

Add cash and release the backing plate.

**Step 5**

Push the cash drawer until it latches closed.

TIPS ABOUT ADDING BILLS:

1. Fan the notes so that the notes are not sticking together.
2. Remove all the notes with holes or notes that are torn.
3. Unfold the folded notes.
4. Place all the notes correctly.

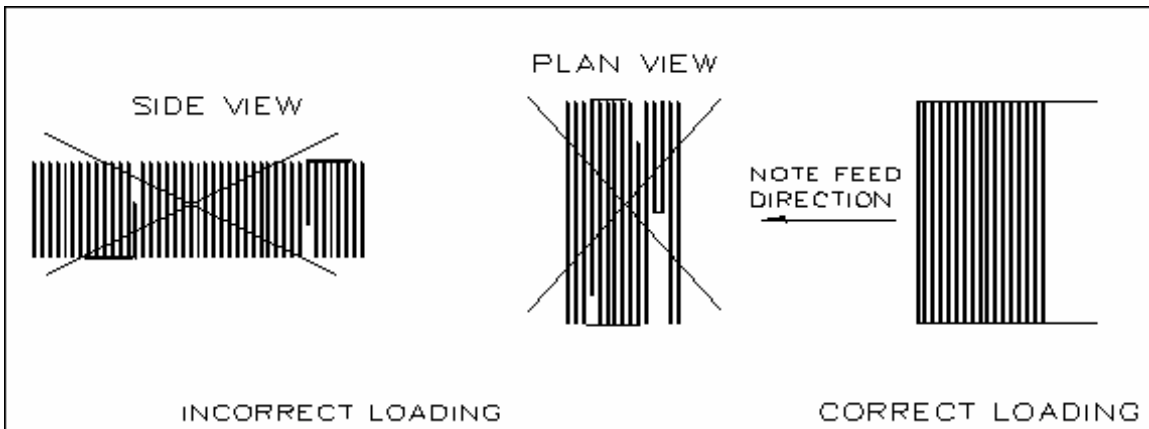

4.2.2 Emptying the Reject Bin

**Step 1**

Pull on the green tab to the right of the Reject Bin to open the Reject Bin cover.

**Step 2**

Open the Reject Bin door and remove any bills that might have been rejected.

**Step 3**

Close the Reject Bin cover by pressing it closed until it locks in place.

END

4.2.3 Loading the Receipt Paper



Step 1

Open the Front Panel. (See 4.1.1.3 Opening the Front Panel.)

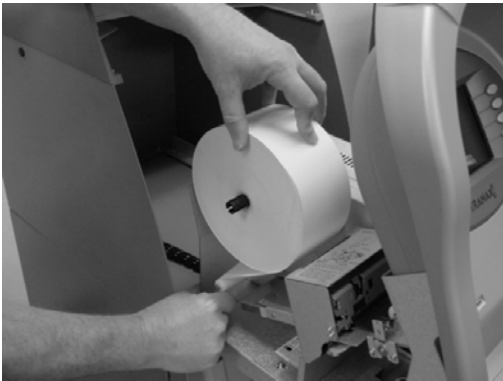

Step 2

Remove the green plastic paper holder by carefully pulling it off. Do not pull up or down on the black spindle. Add the paper roll on to the spindle and replace the green holder.

Step 3

Prepare the new paper roll. Note below.

NOTE:

1. Make sure the roll is in its proper roll form. (A deformed roll may cause jamming problems.)
2. When replacing the new roll, make sure the end of the roll paper is clean cut (See Fig. 1).

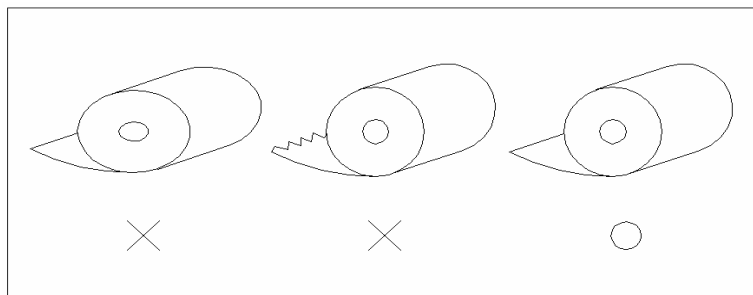

Fig. 1

**Step 4**

Feed the roll so that the shiny side of the paper is up. Using your finger, insert the paper up the loading guide until the paper stops. The paper will not feed until the machine is initialized. If the paper does not feed, make sure the paper is all the way in the loading guide. Also make sure the roller assembly is closed (see below)

**Step 5**

The roller assembly can be opened by pressing down on the green lever in front of the printer.

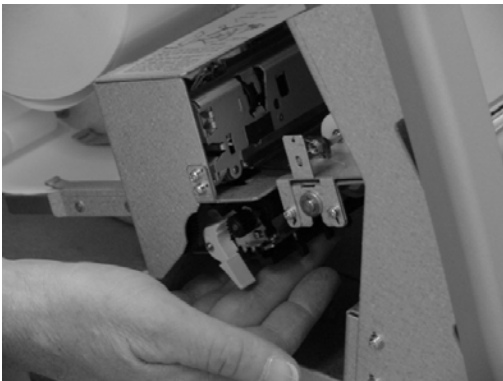
**Step 6**

To close the roller assembly, lift up on the rollers. The roller assembly must be completely closed before the printer will operate.

When finished loading paper, close the top bezel and remove the key.

END

4.3 SETTLEMENT MENU

SETTLEMENT	
DAY TOTAL	TRIAL DAY TOTAL
CASSETTE TOTAL	TRIAL CASSETTE TOTAL
CURRENT # OF BILLS(1) = 0	
CURRENT # OF BILLS(2) = 0	
ADD CASSETTE #1	ADD CASSETTE #2
CANCEL TO RETURN	

Choose Settlement from the Operator Function menu. This menu controls how many bills have been added to the ATM as well as generating Day total and Cassette total reports.

ADDING CASH

Step 1

Press the Add Cassette button for the cassette to be added (1 or 2).

Step 2

Using the main keypad, enter the number of bills added to the cassette (not the amount of money).

Step 3

Press the enter key when finished to set the amount.

END

If you make a mistake and wish to zero out the current number of bills, you'll need to press Cassette total to do this. Anytime you press Add Cassette you will be adding on to the current number of bills already programmed.

For example:

There are 50 bills in the cassette and in the settlement menu it says Current # of Bills = 50. You wish to add 25 more bills to the same cassette, you press Add Cassette, then type 25 from the keypad and press enter. The current number of bills will now be 75.

Now say there are 50 bills in the cassette and in the settlement menu it says Current # of Bills = 50. If you wish to remove 25 bills from the cassette, press Cassette Total. This will return the number of bills in both cassettes to zero and print a

receipt showing remaining bills and loaded bills. Now press Add Cassette and enter 25 from the keypad, press enter to set. The current number of bills will not be 25.

DAY TOTAL

```

                DAY TOTAL
            =====
Start   : 02/01/2001,   15:31:59
Today   : 02/05/2001,   15:40:13
Terminal # : 1234567

< TERMINAL TOTALS >

Count of Withdrawal :      0
Count of Balance    :      0
Count of Transfer   :      0
Count of Non-Cash   :      0
Amount of Dispense  :    $0.00
Amount of Non-Cash  :    $0.00
Amount of Surcharge :    $0.00

< HOST TOTALS >

Count of Withdrawal :    00
Count of Balance    :    00
Count of Transfer   :    00
Amount of Dispense  :   $0.00

```

The Day Total function keeps a running total of the ATMs transaction activity. When you press day total, the ATM will print a report showing transaction totals starting from the last time a day total was done until now. At the same time, the NanoCash will dial into the Host Processor and retrieve their totals for the same time period. To the left is an example of a Day Total Report. Once the report is printed, the ATM will reset these values to 0 and begin recording from this point.

One thing to keep in mind when doing a Day Total is that the Host (or Processor) cuts off their transactions at a certain time every day. If you do a Day Total report before or after the processor has done their cut off, you may see discrepancies between what the terminal had reported and what the host reports.

To avoid this, talk to your dealer and find the approximate cut off time for your processor. Try to do your day totals at this same time. Remember that if you do not match your processor, the missing transaction(s) will usually appear on the next total. If you are unable to do your Day Total at the same time each day you can program the machine to do a "Trial Day Total" automatically (see section 3.2.7).

After the Day Total has printed you will be prompted on the screen that the total has printed and to press the Enter key to return to the menu.

CASSETTE TOTAL

```

          CASSETTE TOTAL
          =====
Start:    02/03/2001,  12:43:36
Today:    02/05/2001,  11:13:52
Terminal #      : 1234567

**** CASSETTE #1 ****
Loaded       :      0
Dispensed    :      0
Rejected     :      0 (1 or more)
Test        :      0
-----
Remaining    :      0
Value of each note = $10

**** CASSETTE #2 ****
Loaded       :      0
Dispensed    :      0
Rejected     :      0 (1 or more)
Test        :      0
-----
Remaining    :      0
Value of each note = "Free Coupon"

```

The Cassette Total function prints a report detailing the number of bills that have been loaded into the cassette and how many bills were dispensed, either to the customer, the reject bin or used during a dispenser test. This report will show totals from the last time you ran a Cassette Total to the current date. After the Cassette Total has been printed, all the values will reset to zero.

NOTE: Running a Cassette Total is the only way to clear the Settlement value back to zero bills. After the Cassette Total has printed you will be prompted on the screen that the total has printed and to press the Enter key to return to the menu.

TRIAL CASSETTE TOTAL / TRIAL DAY TOTAL

These reports are identical to pressing Day Total or Cassette Total, the only difference being that they will not zero out the amounts. This report is useful if you wish to know current Total statistics without closing them out. To run these reports, simply press the button and the report will print. Press Enter when finished to return to the Settlement Menu.

NOTE: Trial Day Total can be set to process automatically at a preset time. See Section 3.2.7 for information on automated scheduling of a Trial Day Total.

4.4 JOURNAL MENU

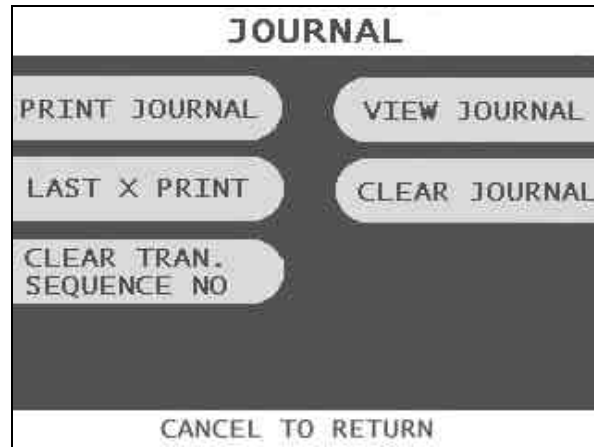

The Journal is an electronic record of all transactions, errors and some programming changes made to the ATM. Depending on the size of each entry, the memory can hold up to 2000 records. Each entry into the journal is indexed with a 4-digit sequence number starting with <0000>. Once the journal memory has reached its maximum limit, it will begin to overwrite the oldest entries. You will not be warned of this, therefore it is critical to make sure to download or print your journal often enough to avoid losing records.

The journal can be printed from the ATM in two different methods, Standard and Condensed. Standard will give complete information for each transaction (basically a copy of the customer's receipt), whereas the condensed print will only show sequence number, date, time, what type of transaction and then amount requested / amount dispensed (in case of withdrawal).

PRINT JOURNAL

Step 1

To print the journal, press the Print Journal button.

Step 2

You will be prompted to choose standard (PRINT) or condensed (CONDENSED PRINT).

Step 3

The ATM will then print all journals in memory up to the last time you printed a journal. Each time you print a journal a marker is set at that point. The next time you print the journal, the ATM will print from that marker to the current time.

END

LAST X PRINT

The Last X Print option allows you to bypass the marker set when printing a journal and go back to recover an older record (so long as the record still exists in memory). For example, you print a journal and it includes sequence numbers <0001> to <0100>. If you wanted to go back and reprint journal number <0080> you would need to do a Last X Print for 20 records (100-20=80) this would give you records 100-80. To do a Last X Print, press the button and then enter a value of how many records you wish to go back.

CLEAR TRANSACTION SEQUENCE NUMBER

This function will reset the journal sequence number back to <0000>. This may be useful if you switch processing or switch Terminal ID numbers and want to keep new records.

VIEW JOURNAL

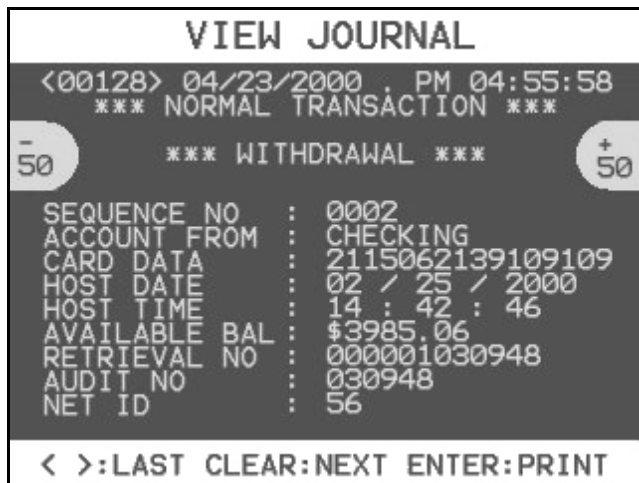

View Journal allows you to visually inspect the journal records. Press the View Journal button and you will see the screen to the left.

Use the Arrow keys on the main keypad to scroll through the records. You can also use the buttons next to +50 and -50 to go forward or backwards 50 records at a time. Use the Enter button to print the journal entry currently displayed. Press Cancel to exit this menu.

CLEAR JOURNAL

Clear Journal sets the current journal marker to the most recent journal recorded. It does not delete the journal from memory. For example: You currently have 100 entries in your journal, you press Clear Journal. Now if you press Print Journal, nothing will happen because there are no current journal entries, however if you used Last X Journal, you could enter 100 and get all the records.

4.5 REPORTS MENU

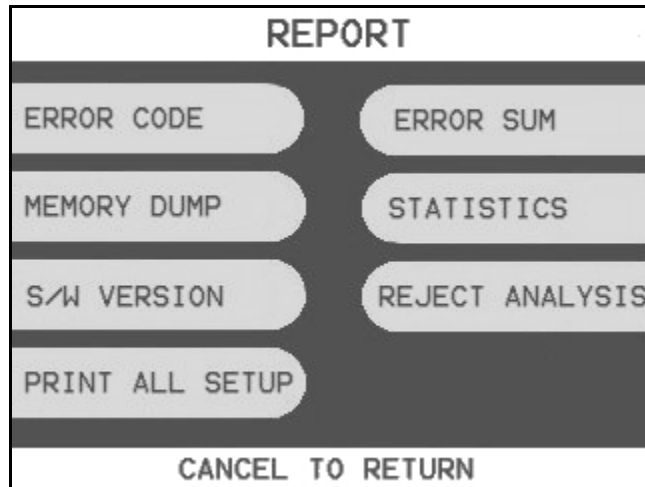

The reports menu provides statistical information as well as troubleshooting and error information.

ERROR CODE

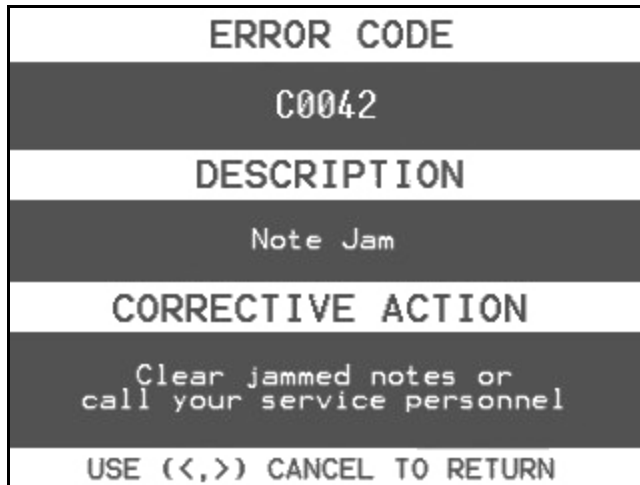

If the machine is out of service, and you are unfamiliar with the error code being displayed (or none is displayed), this screen will provide error descriptions as well as corrective action for the currently displayed code. Press the Error Code button to enter this screen. You can also use your left and right arrow keys on the main keypad to scroll through all the possible error codes and descriptions the ATM can report. To the left is an example of an Error Code screen.

MEMORY DUMP

This feature is a diagnostic tool for factory use only. Do not use this function.

S/W VERSION

This screen provides the current revisions of software used in your ATM. This information may be used to troubleshoot a problem, or simply to make sure that the software being used is up to date. It is useful to have this information when reporting a problem to your dealer / distributor. Occasionally check with your dealer / distributor for software updates. Press the S/W Version button to view the current revisions. Press Enter key to print a copy of the displayed information.

PRINT ALL SETUP

The Print All Setup report is a complete listing of all the programming details for your ATM. It includes everything from software versions to message screens and host setup parameters. This report is extremely important when troubleshooting problems. It is highly recommended to keep a copy of this on hand for when you need to contact your service personal. To print the report, press the Print All Setup button, when the report is finished it will prompt you to press Enter to return to the Reports Menu.

ERROR SUMMARY

ERROR SUMMARY			
Start: 02/01/2001, 11:01:30			
CLEAR	NO.	ERROR CODE	COUNT
	1	D1800	4
PRINT	2	A0803	1
	3	D1704	1
	4	C0011	1
	5	_____	0
	6	_____	0
	7	_____	0
	8	_____	0
	9	_____	0
>>	10	_____	0
CANCEL TO RETURN			

This report is a running total of all errors that have occurred to your ATM. It lists the errors by the number of times they occurred. Sometimes your machine can go out of service and no error code is displayed (usually with communications problems). If this happens, check the error summary, as the code will be displayed here. You can print these errors. To the left is a sample of an error summary report.

Press Clear to clear the report and start over. This can be useful if you have a machine where multiple errors are occurring. If you clear the error codes and then attempt a transaction, if that transaction fails, the error summary will only show those errors that occurred during that last transaction. You can also print the error summary list by pressing the Print button.

STATISTICS

STATISTICS			
WITHDRAWAL	Tr#/ DAY	=	0
NON-CASH	Tr#/ DAY	=	0
BALANCE	Tr#/ DAY	=	0
TRANSFER	Tr#/ DAY	=	0
DISPENSE	NOTES/ DAY	=	0
DISPENSE	NOTES/ Tr	=	0
SURCHARGE	AMOUNT/ DAY	=	0.00
ENTER: PRINT CANCEL: RETURN			

This report keeps running averages of transaction information, including:

- Withdrawal Transactions per day
- Non-Cash withdrawals per day (if enabled)
- Balance Transactions per day
- Transfer Transactions per day
- Notes Dispensed per day
- Surcharge amount collected per day

Use the Enter key on the main keypad to print, Cancel to return to the reports menu.

REJECT ANALYSIS

REJECT ANALYSIS	
CLEAR	Start: 02/01/2001, 11:01:30
	TOTAL DISPENSED = 0
PRINT	TOTAL REJECTED = 0
	SKEW = 0
	GAP TOO CLOSE = 0
	LONG NOTE = 0
	SHORT NOTE = 0
	DOUBLE DETECT = 0
CANCEL TO RETURN	

Reject Analysis a report detailing any bills that may have rejected in your cash dispenser. There are several different causes for a bill to reject, and this report will show specific reasons why. Please note that the count of a particular reject may not reflect the number of bills in the reject bin. For example: the reject analysis may show 3 double detect rejects. However in your reject bin there are 7 bills.

If a bill fails the double detect sensor in the cash dispenser, the sensor can detect that there is more than one bill but not how many more, so all bills in that instance are diverted to the reject bin. Above is the reject analysis screen. Press the Clear button next to the screen to clear the summary and start at zero. Press the Print button next to the screen to print a copy of the reject information.

SECTION 5: DIAGNOSTICS

5.1 DIAGNOSTICS MENU

The ATM features built-in diagnostics features to assist you in troubleshooting any problems that may develop. Below is the main diagnostics menu.

NOTE: Some of the features in the Diagnostics menu may not be available depending on model of MiniBank.

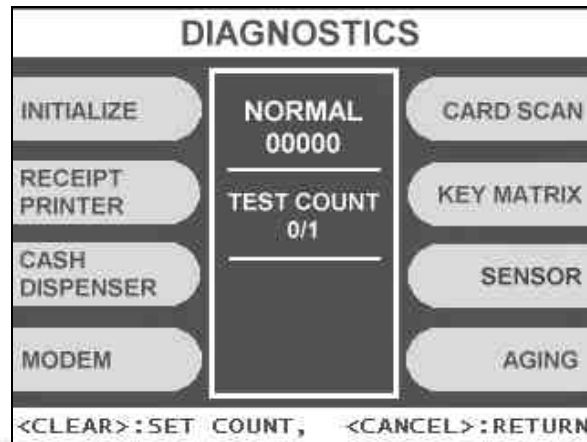

INITIALIZE

This test will cause the ATM to run its Initialization test. This is the same test performed automatically every time you power on the ATM. If an error is detected it will appear under the Test Count on the screen. To run the Initialization test press the Initialize button.

RECEIPT PRINTER

This test will print a test receipt. If the test is successful you should receive a receipt with three sets of sample characters for each time the test is run. You can use the <Clear> button to set the number of times you want this test to run (if you enter a zero for the count the test will run until you stop it by pressing <Cancel>).

CASH DISPENSER

This will test the ability of the cash dispenser to pull a note from one or both cassettes and send it to the reject bin. You can choose from the first cassette, second cassette or both cassettes at once. You can use the <Clear> button to set the number of times you want this test to run (if you enter a zero for the count the test will run until you stop it by pressing <Cancel>).

NOTE: You must have bills entered into Settlement before running this test.

MODEM

The modem test will allow you to enter a phone number into the machine and test dial. To run the test, press the Modem button and then press Test Dial. Using the main keypad, enter a phone number to be dialed (for example your cell phone number) and then press <Enter>. The modem should dial out to the number you entered. To end the call press Modem Hangup. In most cases a failure during the modem test will relate more to phone line problems rather than the modem circuit itself.

CARD SCAN

This will test the three tracks of the card scanner to ensure they are reading properly. Press the Card Scan Button, you will see a screen displaying the three ISO tracks. Swipe your ATM card (or any card with a magnetic stripe) and the information from that card will appear on the appropriate track. During normal operation of the ATM only ISO Track 2 is read, however during the card swipe test all three tracks are read at once.

KEY MATRIX

This tests the keypads of the ATM. Press the Key Matrix button and a map of all keys will display on the screen. Press the different keys on each keypad (main and LCD) and the appropriate key will blink on the screen. Pressing the <Cancel> key on the main keypad will stop this test and return to the diagnostics menu.

SENSOR

This menu will provide detailed sensor status for both the Cash Dispenser and a second menu for auxiliary sensors such as vault door, voice guidance jack and printer. Enter the menu and on screen will be displayed the current value for each sensor. You can use this test in real-time to test each sensor. Blocking or moving a sensor while the menu is visible should change the value presented on the screen.

AGING

The aging test is used at the factory to test machines prior to shipping and for quality control. Selecting this test will cause the machine to perform all self tests for an unlimited amount of time.

SECTION 6: CUSTOMER TRANSACTIONS

6.1 OPENING PROCEDURES

This section explains how to place your ATM in service.

Step 1

Open the front panel and turn the power on. (see page 4.1)

Step 2

If there is no receipt paper, load the receipt paper. (see page 4.12)

Step 3

Open the security door and replenish the cash cassette. (see page 4.9)

Step 4

Go into the OPERATOR FUNCTION mode and input the number of bills in the cash cassette. (See page 4.14)

Step 5

Exit the OPERATOR FUNCTION MODE.

Step 6

After connecting to the processor, the terminal will be ready for service.

Step 7

If the machine is not ready for service, please check the following:

1. Determine if the phone line is properly connected;
2. Determine if all communication parameters are correct;
3. If, after doing the above steps, the ATM is still not in service, contact your service personnel.

END

6.2 WITHDRAWAL TRANSACTION

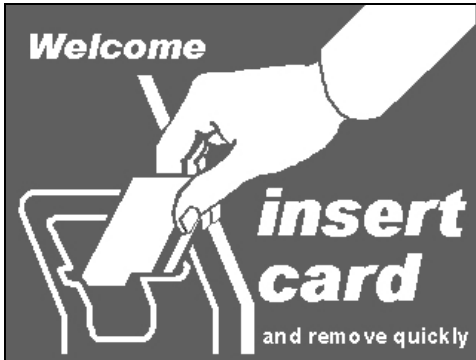

Step 1

Swipe the card.



Step 2

Enter the pin number and press the "ENTER" key.

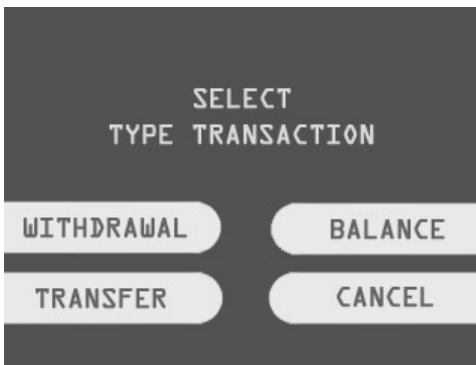

Step 3

Press the "WITHDRAWAL" screen key.

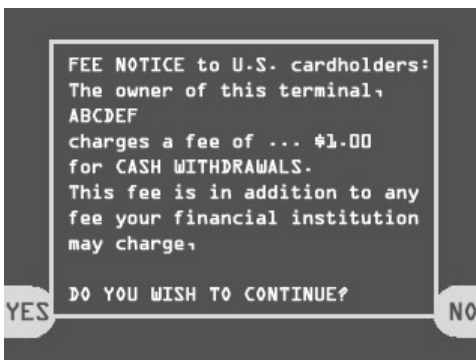

Step 4

If a "SURCHARGE" option is enabled, the "SURCHARGE" screen will be displayed. Select "YES" to continue, or "NO" to cancel.

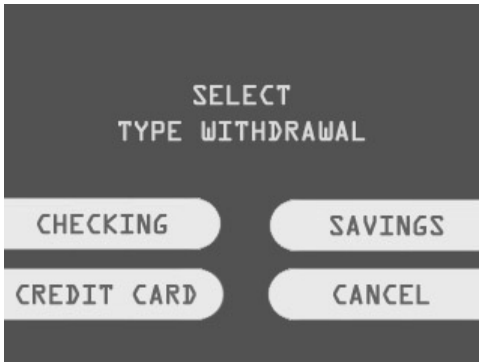

Step 5

If "YES" is selected, the following screen will be displayed. Select the desired option.

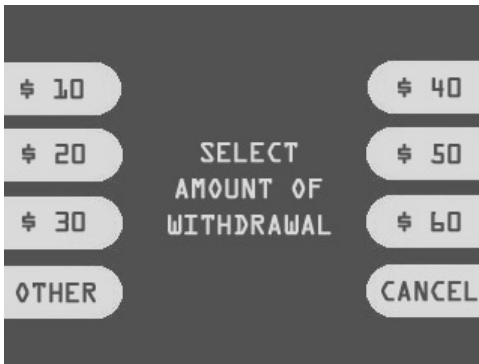

Step 6

Select the desired amount to be withdrawn. If the desired amount is not displayed, select the "OTHER" screen key.



Step 7

After the desired amount is entered, the ATM dials the processor and requests approval for the transaction.

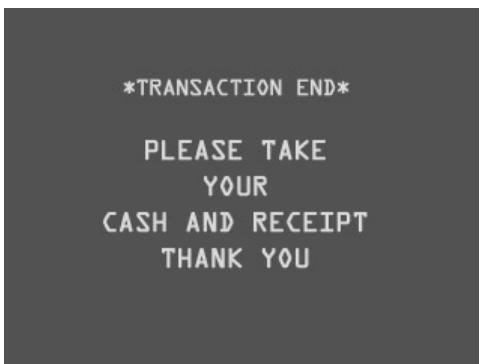

Step 8

When authorization is received from the processor, the cash will be dispensed and the receipt will be printed.

END

6.3 BALANCE INQUIRY TRANSACTION



Step 1

Swipe the card.



Step 2

Enter the pin number and press the "ENTER" key.

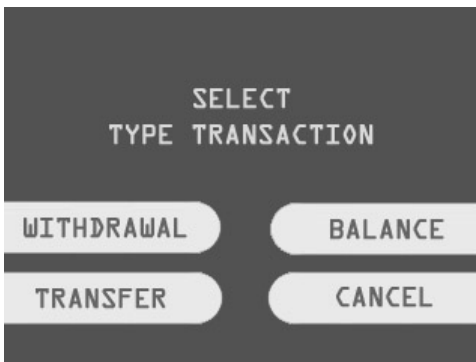

Step 3

Press the "BALANCE" screen key.

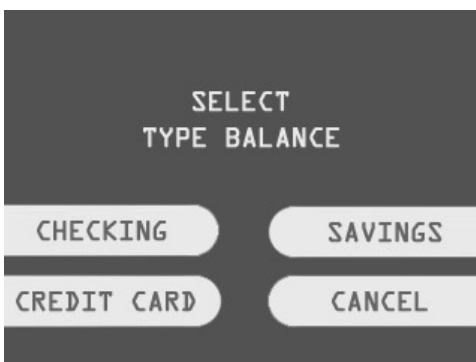

Step 4

The following screen will be displayed. Select the desired option.

Step 5

PLEASE WAIT

CONNECTING

HAVE A NICE DAY

The ATM dials the processor and requests approval for the transaction.

Step 6

TRANSACTION END

TAKE RECEIPT
THANK YOU

When authorization is received from the processor, the following screen will be displayed and the receipt will be printed.

END

6.4 TRANSFER TRANSACTION

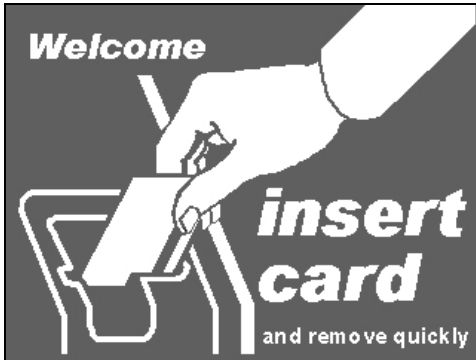

Step 1

Swipe the card.



Step 2

Enter the pin number and press the "ENTER" key.

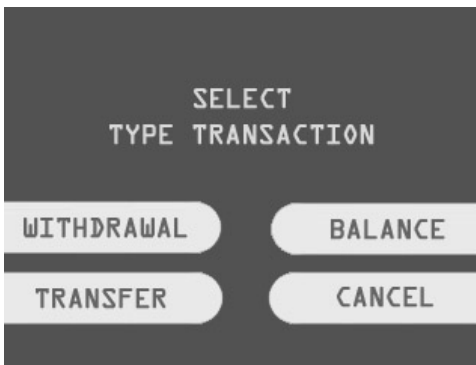

Step 3

Press the "TRANSFER" screen key.

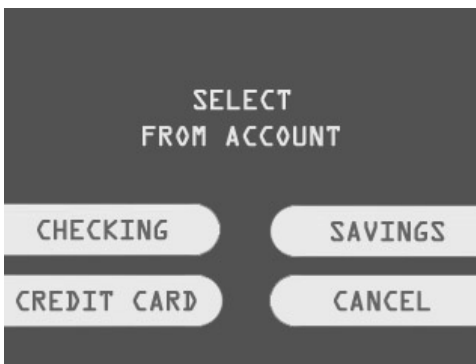

Step 4

The following screen will be displayed. Select the desired account to be transferred "FROM."

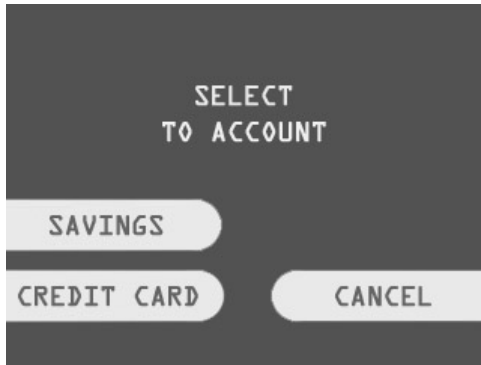
**Step 5**

Select the desired account to be transferred "TO."

**Step 6**

Enter the desired amount to be transferred and press the "ENTER" key.

**Step 7**

The ATM dials the processor and requests approval for the transaction.

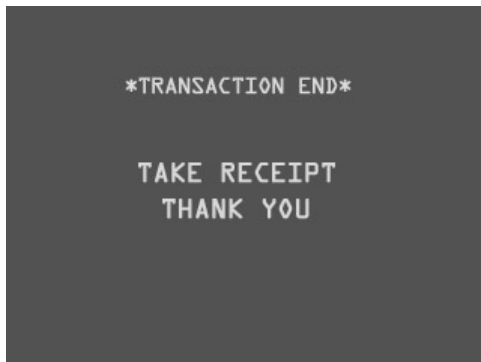
**Step 8**

When the authorization is received from the processor, the following screen will be displayed and the receipt will be printed.

END

6.5 CLOSING PROCEDURE

This section explains the closing procedure for the ATM.

Step 1

Perform the "DAY TOTAL" and "CASSETTE TOTAL" functions in the "OPERATOR FUNCTION MODE."

Step 2

Open the security door. Remove the cash from the Cash Cassette and Cash Reject bin.

Step 3

Print the Journal.

Step 4

If the result of the DAY TOTAL and CASSETTE TOTAL does not match the amount counted in the Cash Cassette, refer to the Journal for verification.

Step 5

Turn the power off and close the security door.

END

6.6 ERROR RECOVERY

If an error occurs the following screen will be displayed.



Step 1

After pressing "ENTER, CLEAR, CANCEL" keys simultaneously, press the 1, 2, 3 keys.

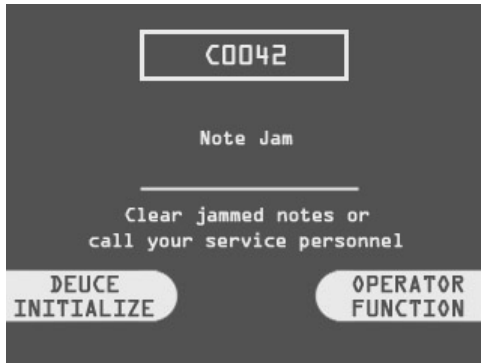

Step 2

Verify the Error that has occurred through the "ERROR CODE" of the "REPORT MENU" in the "OPERATOR FUNCTION," and perform the corrective action, then press the "DEVICE INITIALIZE" screen key.

If the Error is not corrected after resetting, contact your service personnel.

END

APPENDIX A: ERROR CODES

ERROR CODES	ERROR DESCRIPTION	CORRECTIVE ACTION
20001	Unable to load a cassette.	Remove and replace cassette – Check the micro-switch located on the inside left wall of the dispenser.
20002	Low Cash.	Replenish the cash – If using less than 75 bills, disable the “Low Cash Warning” in the Transaction Setup Menu.
20003	Reject Bin full.	Empty the Reject Bin – If the bin is empty, do a Day Total and then a Cassette Total – If that doesn’t help, check AP, BIOS and CDU ROM versions.
20004	Vault Door is open.	Check vault door switch (located upper left corner) – check that black and white, 2-wire connector is properly connected at rear of main board. Bend switch forward to aid closing problems.
20010	Receipt paper jam.	Remove jammed paper – Release receipt paper drawer by pressing the tab with the green sticker located at the front of the printer. Remove printer to locate difficult jams.
20012	Receipt Printer feed lever open.	Close the feed lever on the printer.
20013	Receipt paper empty.	Replenish the paper roll.
20014	Thermal printer is overheated.	Contact manufacturer.
2xx15	Cash Dispenser detects bills prior to dispensing.	Remove any jammed bills from the dispenser.
90001	Card Swipe Error.	This error shows the number of times a customer swipes their card incorrectly. This does not mean the card reader is bad. Just records unsuccessful attempts at swiping cards.
Axxx1	Receipt Printer feed lever open – during operation.	Close the feed lever on the printer.
Axxx2	Thermal printer is overheated – during operation.	If problem is consistent then print head assembly may be defective.
Axxx3	Receipt paper jam.	Remove jammed paper – Release receipt paper drawer by pressing the tab with the green sticker located at the front of the printer.
Axxx4	Receipt paper is empty.	Replenish the paper roll.
Axxx5	Receipt paper is jamming during loading.	Remove any jammed paper and then reload.
Axxx8	Receipt Printer cutter error.	If consistent, printer will require repair/replacement.
ADNxx	Printer connection error.	Check cables between Printer and Mainboard. Remove cables (even though they may be attached) and reconnect.
CANCE	Surcharge Cancel	Customer has canceled the transaction at surcharge.
C001x	CDU sensor is tripped.	Most typically a C0011 error, this would indicate a bill jam at the exit sensor of the Cash Dispenser. Usually caused by a customer putting fingers in the cash drawer during dispense.
C002x	CDU sensor is tripped.	Check dispenser for jammed bills and restart the machine.
C0030	CDU main motor failure.	CDU will require repair/replacement.
C0031	CDU Gate solenoid error.	CDU will require repair/replacement.
C0032	Outlet solenoid error.	CDU will require repair/replacement.
C0033	CDU Encoder error.	CDU will require repair/replacement. Usually caused by loss of battery power to the CDU mainboard.

ERROR CODES	ERROR DESCRIPTION	CORRECTIVE ACTION
C0034	Double Note detect module failure.	CDU will require repair/replacement.
C0035	Double Note detect module failure.	CDU will require repair/replacement.
C0036	Detected notes in path before initializing.	Clear for notes in the Cash Dispenser.
C0039	Gate sensor open during initializing.	CDU will require repair/replacement.
C003B	Notes detected during installation.	Check for notes in the Cash Dispenser. If nothing is found and problem persists, repair is necessary.
C0040	Cassette removed during dispense.	Reset the cassette. Check position of micro switch on right rear wall of cassette bay in the dispenser. Check the condition of the white plastic cassette retaining clips in the dispenser.
C0041	Tried to dispense notes more than 5 times.	Check the condition of the cash in the cassette. Verify that the cash is of good quality. Check that the denomination in Transaction Setup matches the actual denomination loaded.
C0042	Note jam.	Check for notes in the Cash Dispenser.
C0043	More than 10 notes rejected during one transaction.	Verify the quality of the cash. Straighten and shuffle cash in the cassette.
C0044	More than 5 notes rejected consecutively.	Verify the quality of the cash. Straighten and shuffle cash in the cassette.
C0046	CDU hardware failure.	CDU will require repair/replacement.
C0047	Feed error.	Check the notes in the cassette. Feed error occurred where the cash leaves the cassette. Verify that the cassette has cash in it.
C0048	Incorrect bill count.	Verify cash count under settlement.
C004A	Jammed notes.	Check for notes in the Cash Dispenser.
C004B	Long note detected 3 times consecutively.	Verify the quality of the cash. Straighten and shuffle cash in the cassette.
C004C	Miscount of notes between sensors.	Verify operation of exit gate. Check the number of dispensed notes.
C004D	Cash cassette not properly set.	Reset the cassette; check position of microswitch on right rear wall of cassette bay in the dispenser. Check the condition of the white plastic cassette retaining clips in the dispenser.
C004E	Miscount of notes between sensors.	Test CDU using diagnostics. Verify amount of dispensed notes versus requested notes.
C004F	Miscount of notes between sensors.	Test CDU using diagnostics. Verify amount of dispensed notes versus requested notes.
C0050	Power failed during dispense.	Remove any notes from path. Verify amount of dispensed notes.
C0051	Over 150 notes requested.	Possibly due to too many rejects. May require repair is consistent.
C0052	Detected notes in path after dispense.	Remove any notes from path. Verify amount of dispensed notes.
C0053	CDU double detect module failure.	CDU will require repair/replacement.
C0055	Detected long notes at outlet sensor.	Check quality of cash. Verify that denomination matches actual loaded cash.
C0056	Exit gate sensor failure.	CDU will require repair/replacement.
C006x	Sensor failure.	Check sensors for debris. Contact manufacturer.
C007x	Sensor failure.	Check sensors for debris. Contact manufacturer.

ERROR CODES	ERROR DESCRIPTION	CORRECTIVE ACTION
C0082	Shutter failure.	CDU will require repair/replacement.
C0083	Stacker sensor failure.	CDU will require repair/replacement.
C0084	Shutter close error.	CDU will require repair/replacement.
CDNx	CDU connection failure.	Check cables between CDU and Mainboard. Remove cables (even though they may be attached) and reconnect. This error is of concern only if it is repeated. Outside interference may cause it.
D0001	Modem initializing failure.	This error is reported from the host. Check that programming is correct for this processor. Not likely a defective modem.
D0002	Reversal transaction failed.	Check transaction with the processor. Verify CDU functionality with diagnostics. Verify phone connection.
D0012	Invalid transaction.	Code reported from host processor.
D0013	Invalid Amount.	Code reported from host processor.
D0014	Invalid Card Number.	Code reported from host processor.
D0020	Surcharge screen should have been displayed.	Code reported from host processor.
D0024	Exceeds issuer withdrawal limit.	Code reported from host processor.
D0039	No credit account.	Code reported from host processor.
D0051	Insufficient funds.	Code reported from host processor.
D0052	No checking account.	Code reported from host processor.
D0053	No savings account.	Code reported from host processor.
D0054	Expired Card.	Code reported from host processor.
D0055	Invalid PIN.	Code reported from host processor – If processing through Coredata verify that Dual-Masterkey is enabled (Injected Master Key only) – all other processors are disabled.
D0057	Transaction not permitted – card	Code reported from host processor.
D0058	Transaction not permitted – Terminal	Code reported from host processor.
D0061	Exceed withdrawal limit.	Code reported from host processor.
D0075	Number of PIN tries exceeded.	Code reported from host processor.
D0078	No Account.	Code reported from host processor.
D0080	Invalid Date.	Code reported from host processor.
D0083	Cannot verify PIN.	Code reported from host processor.
D0086	Cannot verify PIN.	Code reported from host processor.
D0091	Bank unavailable.	Code reported from host processor.
D0092	System unavailable.	Code reported from host processor.
D0093	Transaction serial number mismatch.	Contact host processor.
D0094	Record format mismatch.	Contact host processor.
D0095	Routing ID mismatch.	Verify Routing ID number – Contact host processor.
D0096	Terminal ID mismatch.	Verify Terminal ID number – Contact host processor.
D0097	Response type mismatch (reversal).	Contact host processor.
D0098	Response type mismatch (day-close).	Contact host processor.
D0099	Response type mismatch (Configuration).	Contact host processor.
D009A	Response type mismatch (Withdrawal, Balance, Transfer).	Contact host processor.
D009B	STX omitted.	Contact host processor.
D009C	ETX omitted.	Contact host processor.

ERROR CODES	ERROR DESCRIPTION	CORRECTIVE ACTION
D009D	FS omitted (after response code).	Verify that version of Mini-Bank Software matches host processor. Contact host processor.
D009E	FS omitted (after retrieval reference number).	Verify that version of Mini-Bank Software matches host processor. Contact host processor.
D009F	FS omitted (after system trace audit number).	Verify that version of Mini-Bank Software matches host processor. Contact host processor.
D00A0	FS omitted (after account balance).	Verify that version of Mini-Bank Software matches host processor. Contact host processor.
D00A1	FS omitted (after available balance).	Verify that version of Mini-Bank Software matches host processor. Contact host processor.
D00A2	FS omitted (after available balance).	Verify that version of Mini-Bank Software matches host processor. Contact host processor.
D00A3	FS omitted (after authorization response text).	Verify that version of Mini-Bank Software matches host processor. Contact host processor.
D00A4	ETX is in wrong place.	Verify that version of Mini-Bank Software matches host processor. Contact host processor.
D00A5	FS omitted (after total cash dispense amount in day close).	Verify that version of Mini-Bank Software matches host processor. Contact host processor.
D00A6	FS omitted (after total non cash dispense amount in day close).	Verify that version of Mini-Bank Software matches host processor. Contact host processor.
D00A7	FS omitted (after surcharge amount in day close message).	Verify that version of Mini-Bank Software matches host processor. Contact host processor.
D00A8	FS omitted (after surcharge in configuration message).	Verify that version of Mini-Bank Software matches host processor. Contact host processor.
D00A9	ETX omitted (from configuration message).	Contact host processor.
D0300	Modem is not responding.	Verify modem function.
D1000	No Connection.	Verify modem function.
D1100	ENQ not received from host.	Contact host processor.
D1200	Transmission error.	Verify modem function.
D1300	NAK sent 3 times to host.	Verify host phone number – See D170x.
D1500	Modem connection time out – host not responding.	Verify host phone number – verify modem speed – See D170x. If consistent, it could be a defective modem.
D170x	Modem cannot support connection – excessive line noise (usually D1704/06)	Phone line connected to ATM will not support Data-communication. In line filter may fix this. Excessive EMI emissions from outside source (neon sign, freezer).
D1800	No dial tone.	Verify that incoming phone line is plugged into “line” rather than “Phone” on mainbaord. Phone line is in use or is being shared with another phone device (FAX, POS, phone)
D1900	No answer.	Verify host phone number – See D170x
D2000	Phone line busy.	Verify host phone number – call line with handset and check for busy signal – See D170x
D2100	Modem initializing error.	Check modem.
D2200	EOT not received from host.	Contact host processor.
E000x	RMS port failure, response time out, modem failure, no dial tone.	Verify RMS settings (Host Setup) – See D170x

ERROR CODES	ERROR DESCRIPTION	CORRECTIVE ACTION
F0001	Current Number of bill is 0.	Load notes into the cash cassette – use Add Cassette function in Settlement.
F0002	No Surcharge Owner set.	Set Surcharge owner – (Customer Setup)
F0003	No Surcharge Amount.	Set Surcharge amount – (Customer Setup)
F0004	No refresh time set when advertisement is enabled.	Set refresh timer – (Customer Setup)
F0005	No Advertisement text when advertisement is enabled.	Set Advertisement text – (Customer Setup)
F0006	Dispense limit set error (must be less than 25 notes)	Set Dispense limit – (Transaction Setup)
F0007	Denomination Set error.	Valid Denomination are \$10, \$20, \$50, \$100 – (Transaction Setup)
F0008	Fast Cash Set error (cannot exceed dispense limit).	Check the Fast Cash amount. (Transaction Setup)
F0009	Master Key index is invalid.	Check Master Key index – verify checksum (Host Setup)
F000A	Master Key is empty.	Check Master Key checksum – reinject key (Host Setup)
F000B	Host Telephone Number is not set.	Set Host Telephone Number – (Host Setup)
F000C	Error Retry timer is not set.	Set Error retry time (Host Setup)
F000D	RMS Password is not set when RMS is enabled.	Set RMS Password – (Host Setup)
F000E	RMS phone number is not set when RMS send is enabled.	Set RMS Phone number – (Host Setup)
F000F	Terminal ID is not set.	Set Terminal ID number – (Host Setup)
F0010	Routing ID is not set.	Set Routing ID number – (Host Setup)
F0011	Master Key Serial number is not set	Set Master Key serial number – (Host Setup)
F0013/ 14	NVRAM Failure	Fatal error, defective memory chip. Replace Mainboard.

APPENDIX B: KEYPAD ADDENDUM

Mini-Bank 1500™ : Use the following keypad layout for entering Master Key characters.

DO NOT use the LCD buttons for entering the Master Key.

1	2	3	F
4	5	6	E
7	8	9	D
A	0	B	C

Use the LCD buttons to access Download mode and to clear NVRAM.



APPENDIX C: TDES Key Installation

TDES Master Key Installation

Triple - Data Encryption Standard or TDES was designed as a way to strengthen the security of the master key by upgrading from a 16 bit key to a 32 bit key. In addition to the required software changes to support the TDES, the specification calls for a pin-pad to encrypt any data sent between the keypad and the CPU. In this new configuration the master keys are stored securely within the pin-pad, rather than the mainboard as done previously.

Hardware Specification:

Mini-Bank 1500™ (color or mono) with EPP (Encrypted Pin Pad)
**All Mini-Bank 1500™ have shipped with TDES capable hardware.*

Installation Procedure:

To access the Key Management menu from Host Setup, you'll need to enter the Secure Mode Password (parts 1 and 2). See page 3.6 for Secure Mode instructions.

NOTE: Applicable to V10.01.08 / V10.11.08 AP (or higher) ONLY – earlier versions do not have additional password for Key Management Area.

Default Secure Mode password is:

Part #1 = 000000 / Part #2 = 000000

KEY MANAGEMENT	
KEY MODE	EDIT KEY
KEY INDEX	INJECT MASTER KEY
CHECK KEY	SET MASTER KEY SERIAL NUMBER
KEY MODE : UNIQUE KEY, TDES KEY INDEX : 12 KEY CDIGIT : 0C6D	
CANCEL TO RETURN	

Access the Key Mode selections by entering the operator function menu [Cancel] + [Clear] + [Enter] – 1, 2, 3 (see operator manual).

Enter Master Password and choose Host Setup

Note: *Master Password is required to change master key.*

1) **Select Key Mode**

The table below describes the format for each key mode.

DES	2 - 16 digit master keys entered as Part A and Part B.
Dual Master Key	2 - 16 digit master keys entered as Part A and Part B (a common key is entered, and then a working key is downloaded from the host).
Unique Key, DES	2 - 16 digit master keys entered as Part A and Part B - with 10 digit unique serial number entered prior to each part.
TDES	2 – 32 digit master keys entered in 16 digit pieces, Part A (left and right) and Part B (left and right)
Unique Key, TDES	2 – 32 digit master keys entered in 16 digit pieces, Part A (left and right) and Part B (left and right) - 10 digit unique serial number entered prior to each part.
MAC	2 -16 digit master keys entered as Part A and Part B, with 2 additional 16 digit numbers entered as MAC Part A and Part B
Unique Key, MAC	2 -16 digit master keys entered as Part A and Part B, with 2 additional 16 digit numbers entered as MAC Part A and Part B - 10 digit unique serial number entered prior to each part of the master key only.
TDES, MAC	2 – 32 digit master keys entered in 16 digit pieces, Part A (left and right) and Part B (left and right), with 2 additional 16 digit numbers entered as MAC Part A and Part B

Unique Key modes use a unique 10 digit serial number that is entered before each half of the master key to allow the processor to bind the key to the terminal ID automatically. In cases where the processor provides a serial number that is less than 10 digits, zeros must be added at the beginning of the number to equal 10 digits.

2) **Enter Master Key**

Master Key security requires that no one person has access to all parts of the key. To ensure this, the processor will provide keys in separate sealed envelopes (sometimes referred to as “com-velope” or “key components”. Each envelope contains either one or two 16 digit keys and in the case of unique key, a serial number. The diagram below shows a sample Unique Key, TDES master key.

Date Stamp: 05/15/2003	
Serial #: 235913	
Digits L:95D1 R:8A4C 3D:E130AB	
Left Part: 4536 5A3C D349 AB27 Right Part: 2352 6AD3 F1CC 628A Left Check Digit: 81D3 Right Check Digit: 712A Single DES Encryption uses left part only.	

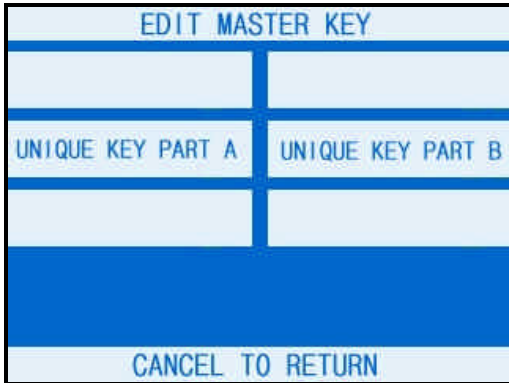

Begin by choosing Edit Master Key from the menu

Depending on Key Mode, the menu prompts for Part A and Part B.

The Edit Master Key interface is designed so that Parts A and B can be entered at completely different times and in either order (Part A first, or Part B first). If a technician is dispatched to enter a key part, choose Check Key from the Key Management menu to determine which part of the key has already been entered.

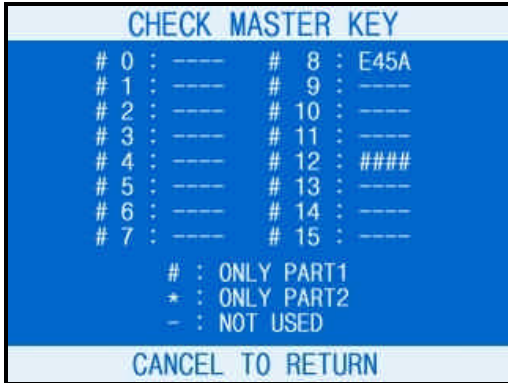

In this example we see that a complete key has been entered in Index #8 and that only Part A has been entered for Index #12.

This would tell the second technician that they need to enter their key as Part B on index 12.

Part1 = Part A / Part2 = Part B



Once you have selected Part A or B, you'll be prompted to enter a Key Index.

This index points to the location where the key will be stored. There are 16 possible memory locations (0-15) available. Unique master keys must be stored at location #12, and MAC keys at location #15.

The interface will default the values for Unique and MAC keys regardless of what you enter. It is very important to remember that both parts of a key must be entered on the same index. If you enter Part A on index #2 and Part B on index #3 the key will not be complete. Use the Check Key function (shown above) to determine where your keys parts have been entered.

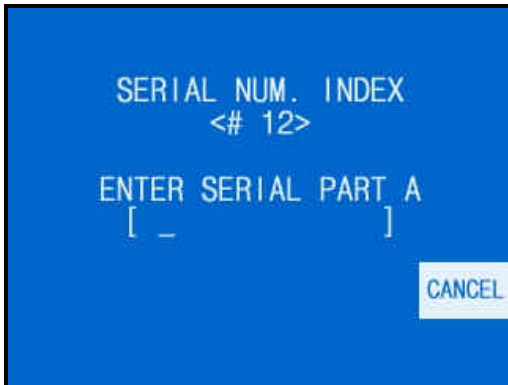

If entering a Unique key, next you'll be prompted to enter the key serial number.

This 10 digit number is found on the paperwork containing your master key(s). If the number the processor has provided is less than 10 digits, you'll need to add zeros to the **beginning** of the number to equal 10 digits.

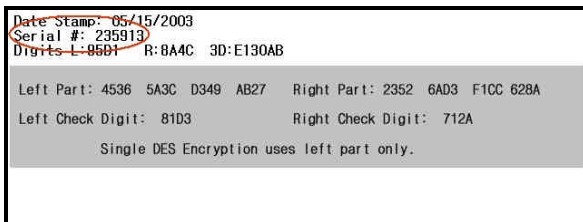

In the example shown at left, the serial number is 235913. This 6 digit number would be changed to 0000235913 to create 10 digits.

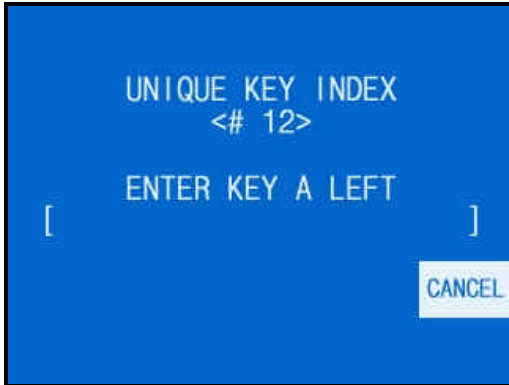

The next step is to enter the master key itself. If you are using TDES, you'll need to enter the left portion first.

After entering the key, you'll be prompted to enter it a second time for verification.

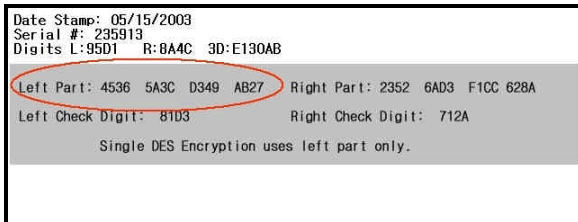

The 16 digit alpha-numeric key is entered using the pin-pad only.

Letters are entered by using the arrow and function keys. Use the pin-pad layout below.

1	2	3	F
4	5	6	E
7	8	9	D
A	0	B	C

EPP (Encrypted Pin Pad) Master Key Alpha-Numeric Key Layout

At this point the left (or first 16 digit) portion of the master key has been entered successfully.



If you are entering a 32 bit key (TDES), the second or "Right" half of the key is entered next.

This option will only appear when in TDES mode.

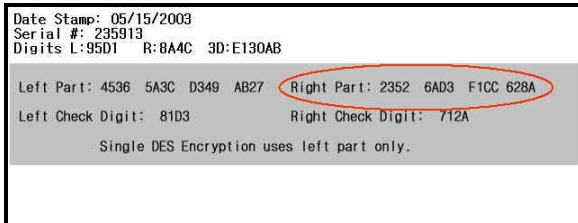

After entering the right portion of the key successfully you'll be prompted with a check digit as shown below. Verify the check digit with the information provided by the processor.

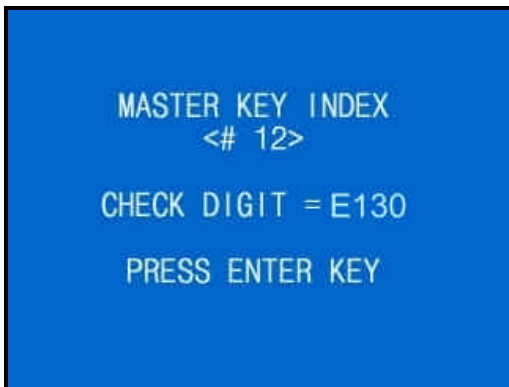

Check digits appear after entering both the right and left portion of each part of the key.

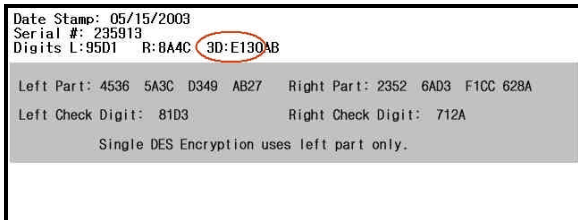

Compare the check digit against the number located at the top of the key component. This represents a check digit for the combined keys. There is not a check digit shown for left and right portions individually.

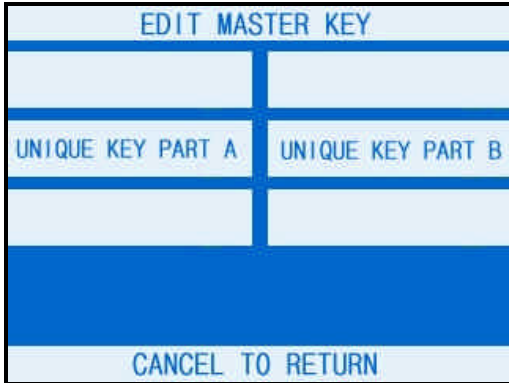

After successfully entering both the left and right portions of Part A, you'll be returned to the Edit Master Key menu.

At this point you can proceed with Part B, or if Part B is to be entered at a later time you can exit the menu and power off the machine until both halves of the key are entered.

Part B is entered with the same procedure given for Part A. Enter the left and right (for TDES) portions of the keys and verify the check digits against what has been provided by the processor.

3) Verifying Master Key

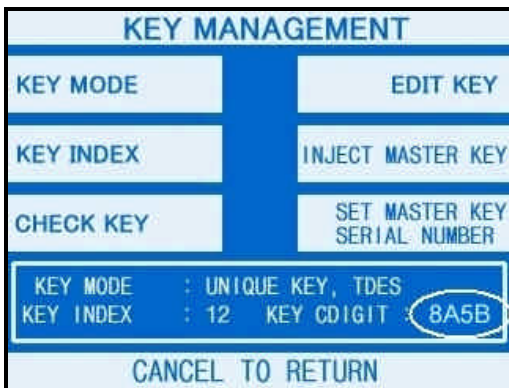

Once both Part A and Part B have been entered successfully, the key management menu will display a check digit for the key index where the master key was entered. If no check digit is entered, use the check key screen to determine where the key parts were entered, then re-enter the keys as necessary.

At this point, the master key is successfully entered. If all other parameters have been entered properly, power off the ATM and power on to connect to host and initialize the keys.

APPENDIX D: Advertisement Graphics



How to create and install custom graphics

(excludes PC based Mini-Bank™ ATMs)

On screen graphics are available on the following Tranax Mini-Bank™ ATMs

Mini-Bank 1000™	(with TDES upgrade, V10.xx AP software)
Mini-Bank 1500™	(with V10.xx AP software)
Mini-Bank 2000™	(with TDES upgrade, V10.xx AP software)
Mini-Bank 2100™	All
Mini-Bank 2200™	All
Mini-Bank 2150™	All
Mini-Bank 2250™	All
Mini-Bank 2100T™	All
NanoCash™	All

Graphics are displayed when the ATM is idle, and also while a transaction processes. The graphics are individual frames and are displayed in a “slide-show” format. Once images have been loaded to the ATM, you can control which images display, however you cannot control which order.

On-screen graphics are controlled in the Advertisement section of the Customer Setup menu.

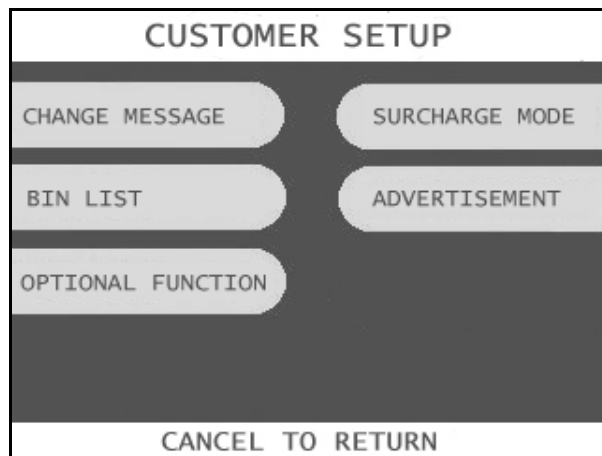

(sample customer setup menu)

Depending on which model Mini-Bank™ ATM, and which software version is installed you can display from 5 to 8 unique graphics. The Advertisement menu segregates the screens into “Primary” and “Secondary” sub menus. Primary screens are graphics #1 through #4, and secondary are the remaining open locations.

Creating Graphics

What is required?

Tranax Mini-Bank ATMs require a .PCX image format. Make sure the program you'll use to create any graphics is capable of saving or exporting as a PCX image (NOTE: *Windows Paint will not save as PCX*)

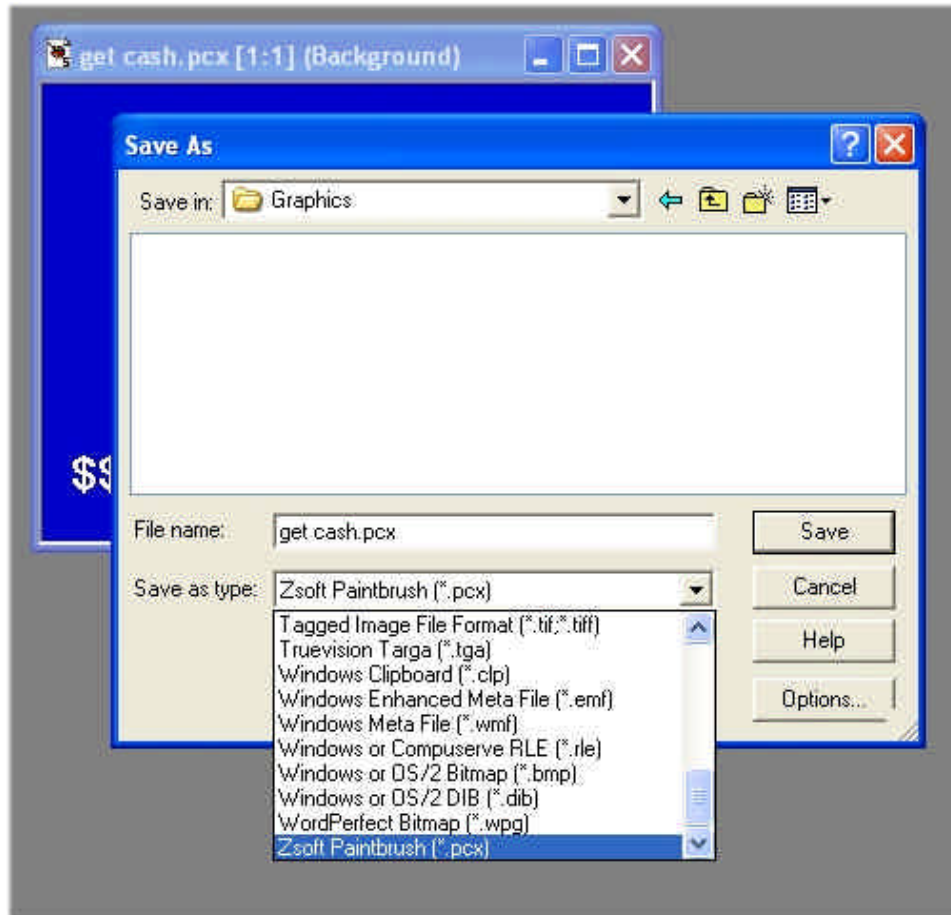

Tranax recommends "Paint Shop Pro" however any program which allows you to save a file in .PCX format will work. A trial version of Paint Shop Pro is available from www.download.com or www.jasc.com.

Paint Shop Pro is particularly useful because it will allow you to upload a color palette file into the program which more accurately represents the 256 colors available on the Mini-Bank color screens. The mini.pal palette file is available on the Tranax website, packaged with the graphics conversion utility.

Step 1: Creating the graphic

Within your graphics program, create a new image and set the image parameters for 320 pixels wide by 240 pixels tall. It is not recommended that you reduce larger existing images as the reduction will likely affect quality.

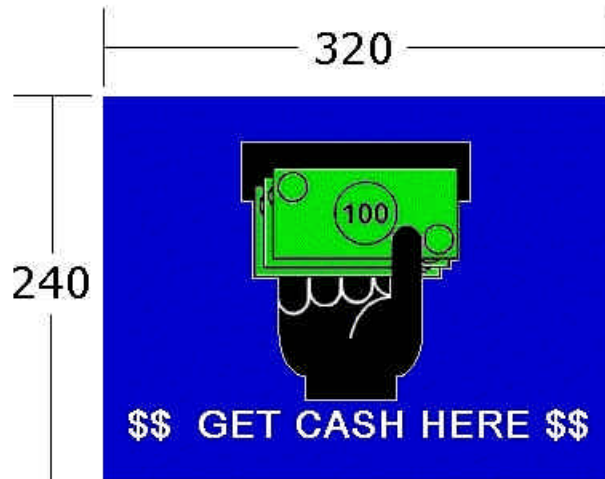

If the image you are creating will be used on a Mini-Bank with a color LCD screen, you'll need to see the colors for the image at 256 (8-bit). This is typically done in the same setup screen where you set the resolution.

If creating graphics for a Mini-Bank with a monochrome or mono-transreflective LCD screen set the color properties to 2 color (1-bit).

Once the new image has been created, you're ready to fill it with whatever your artistic talent can muster. Some guidelines and helpful tips:

- Do not import scanned images or photographs. These are high color (usually 16 million) and when reduced to 256 will look horrible.
- If you have an existing logo in .JPG or .BMP format, reduce the colors for that image prior to cutting and pasting into the new image.
- There will be a blue banner approximately 3/8" tall across the top portion of the screen to tell the customer the transaction is processing. Remember this when planning your graphic so as not to have the banner cut through the top. Center your image in the 320x240 space a little low to compensate. You can also use a blue background (as we did in the above sample) which blends into the banner. The banner cannot be disabled.

Once the image has been created, make sure to save it in the .PCX format.

Step 2: Converting the graphic

The file as saved to your computer cannot be loaded directly to the ATM. We have a utility application (available free from the Tranax website) which converts the PC file into a structure useable by the ATM. Download and install the Tranax Graphics Conversion Utility.

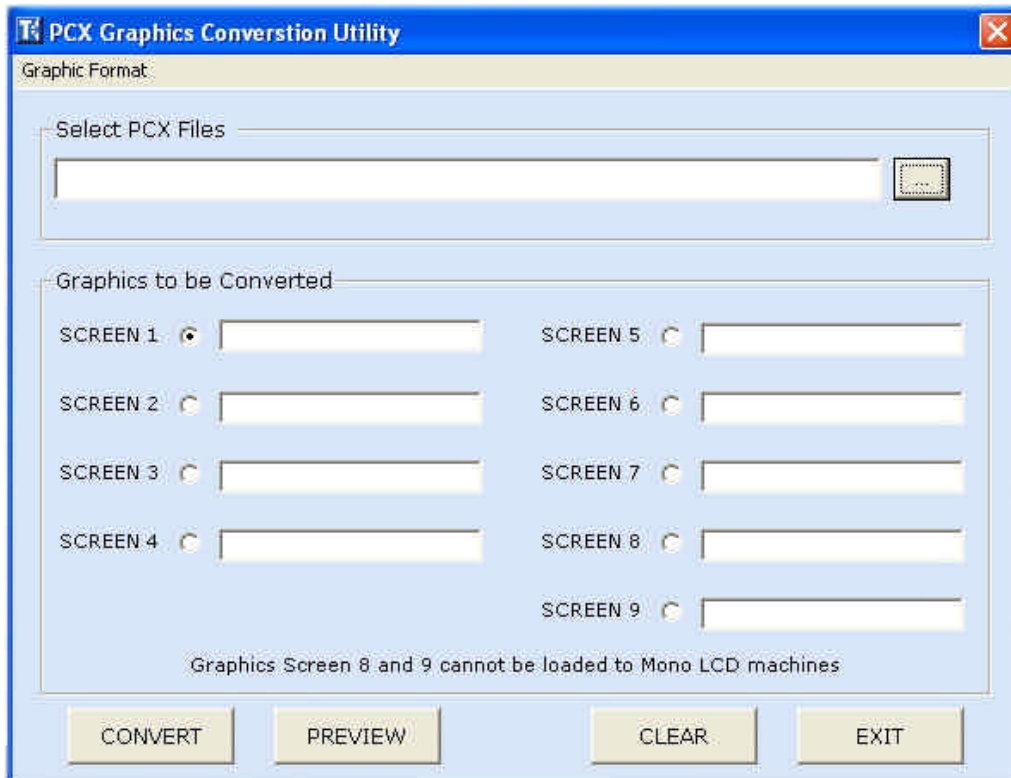

This utility will take your existing .PCX image, convert and rename the file into the format required by the ATM and save it in a folder called Converted_Graphics on your desktop.

You must use this utility. If you upload files created on your PC directly to the ATM it will corrupt the memory and in some cases require the mainboard to be re-flashed.

Choose which screen position you'd like the new graphic to be saved to (you do not have to go in order) you can select multiple graphic screens for conversion at the same time, however only one file for each screen.

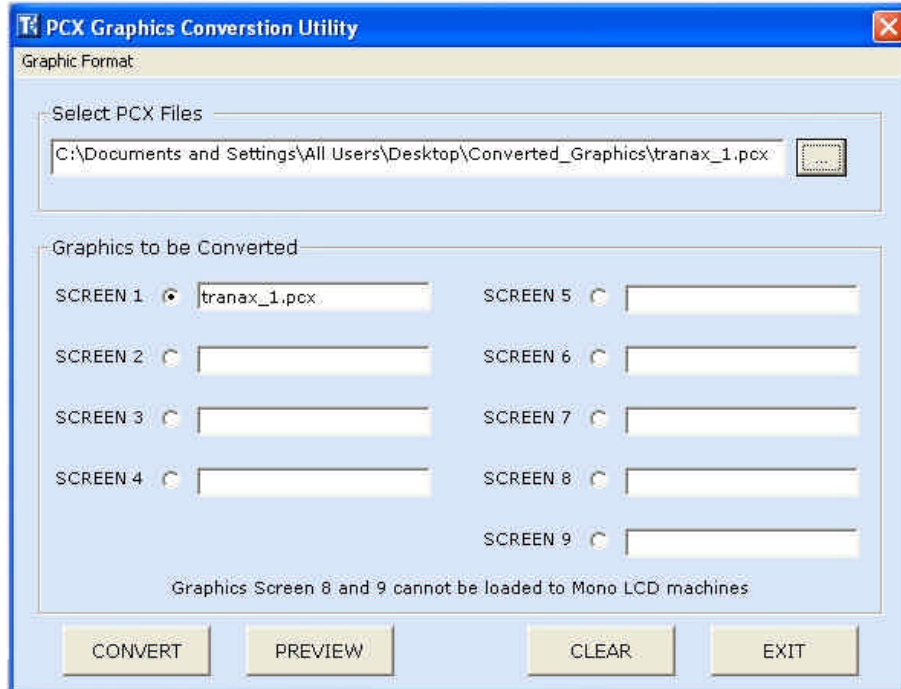

Begin by clicking a screen number and then click the [...] button in the "Select PCX Files" box to browse your computer for the new file you created.

To preview the file and make sure it's the correct one, use the preview button. The preview function is only available on PCs with the Microsoft Photo Editor component of Windows installed (Windows XP has this, earlier versions might not)

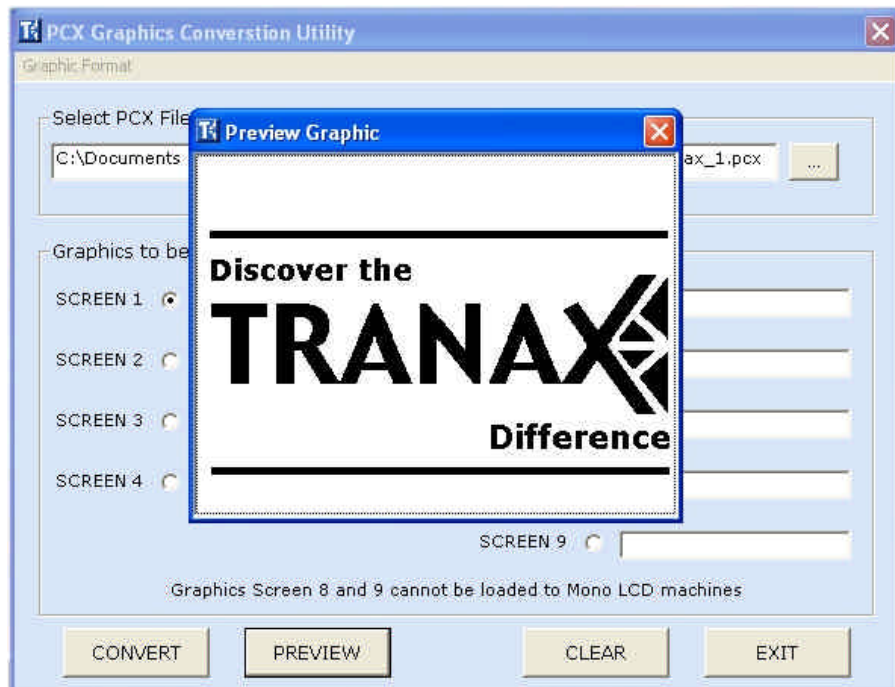

Once you have selected a graphic for conversion, click the Convert button to finish the process.

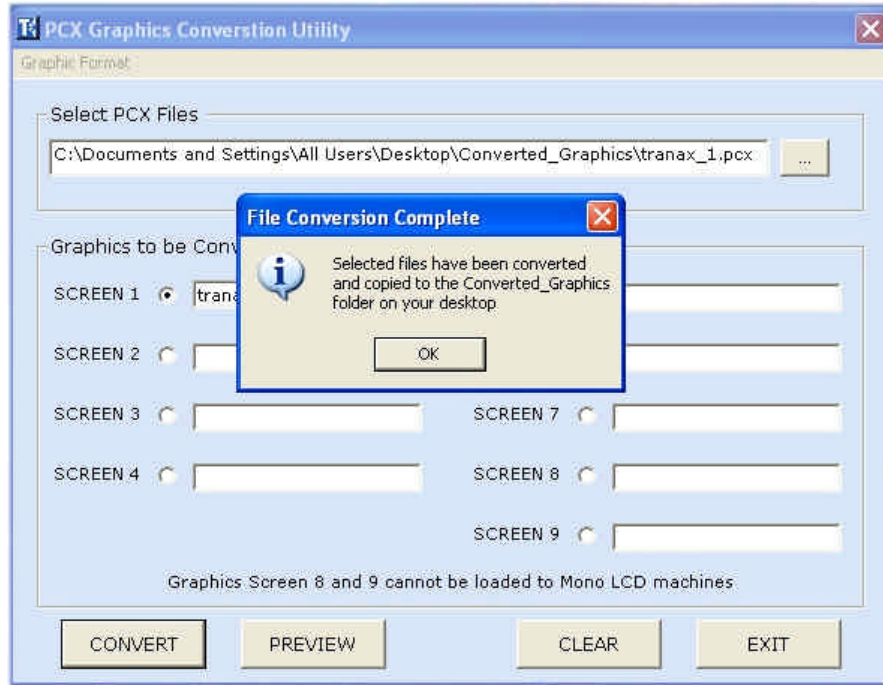

The program will notify you that the files have been successfully converted and are now saved in the Converted_Graphics folder on your desktop.



The files are named according to which screen space they will occupy. For example a file converted to be sent to screen #1 will be named M_PCX1.pcx

Do not change the file names or try to edit the file once it has been converted. This will corrupt the graphic screen.

The only error which may be encountered when converting is if the file size of the graphic to be converted is greater than 59kb. The only way to create a file this large (in .pcx format) is by trying to import a detailed scanned image or photograph into your graphic during creation. If the file size is too large, you'll have to reduce the complexity of the graphic and try again.

Step 3: Loading the graphic to the ATM

Once the graphic has been created and converted, it's ready to be uploaded to the ATM. To do this you have two options.

RMS Pro RMS Professional will allow you to upload graphics via a phone connection directly to the ATM, you can also enable/disable them remotely using this program.

Cable Using a PC or Laptop and a Tranax AP download cable you can download the graphics at the ATM site. Part number TCY00002

RMS

Use the following procedure to upload a graphic using RMS Professional

- 1) Enter the ATM information into RMS per the RMS instruction manual and request a "Setup".
- 2) Highlight the ATM you'll be sending the graphic to in the main window in RMS.
- 3) Choose [Send] from the menu at the top of the RMS window.
- 4) The [Send] command has three options,
 - [Application File Download *.bin]
 - [Advertise File Download *.pcx]
 - [Setup Report]
- 5) Choose [Advertise File Download *.pcx] and click [Config]
- 6) Browse to the folder where you extracted the M_PCX1.PCX file. (this would be the Converted_Graphics folder on your desktop)
- 7) Select the file and click [Open]
- 8) At this point you'll have the option to name the image (for reference only) you do not have to enter anything.
- 9) Click [OK] and you'll then be given the choice to create a receipt coupon to accompany this advertisement. If you do not want a coupon, leave it blank.
- 10) Click [OK] again and you'll be notified that RMS is about to send the graphic. Click [OK] to confirm.
- 11) RMS should now dial out to the ATM and upload the graphic. (this takes 1-3 min)
- 12) Next, to enable the graphic that was just sent go back and follow steps 3, 4 and 5 again except this time choose [Setup Report]
- 13) When the Setup Report opens, click on the [AD TITLE – COUPON] tab and set [m_pcx1:] to Enable.
- 14) Click [SEND] at the bottom of the report and you'll be prompted to confirm before the report will be sent.
- 15) Once the report has been successfully uploaded the graphic should start displaying on its own.

Cable Upload

To upload a graphic directly at the ATM using a PC and download cable, do the following steps.

A. For Mini-Bank™ ATMs with BIOS ver LESS than V10.xx.xx

- 1) To download directly at the ATM requires a PC, the CDOWN6.EXE application and a special Tranax download cable.
- 2) Connect the PC to the to the 9-pin serial port located on the front of the ATMs mainboard (behind the LCD panel)
- 3) Turn off the ATM, then hold down the [Enter] key on the ATM keypad while turning the ATM back on. This will place the ATM in "download mode"
- 4) Both the CDOWN6.EXE and the converted image (ie M_PCX1.PCX) files need to be in the same folder, located somewhere on your hard drive that you can access from a DOS prompt.
- 5) Open a DOS prompt and change to the directory where these files exist.
- 6) Type CDOWN6<space>1<space>8 and press [Enter] (<space> = press the space bar)
- 7) If the proper cable was attached correctly, the program should be counting up in hexadecimal and displaying the file being loaded.
- 8) When the file has uploaded, power off the ATM and power on.

B. For Mini-Bank™ ATMs with BIOS V10.xx.xx and greater (Cashworks)

- 1) To download directly at the ATM requires a PC, the DOWNLOAD.EXE application and a special Tranax download cable.
- 2) Connect the PC to the to the 9-pin serial port located on the front of the ATMs mainboard (behind the LCD panel)
- 3) Turn off the ATM, then hold down the 3rd button down, right side of the LCD panel while turning the ATM back on. This will place the ATM in "download mode"
- 4) Both the DOWNLOAD.EXE and the converted image (ie M_PCX1.PCX) files need to be in the same folder, located somewhere on your hard drive that you can access from a DOS prompt.
- 5) Open a DOS prompt and change to the directory where these files exist.
- 6) Type DOWNLOAD<space>1<space>(B through H depending on what image number) and press [Enter] (<space> = press the space bar)
- 7) If the proper cable was attached correctly, the program should be counting up in hexadecimal and displaying the file being loaded.
- 8) When the file has uploaded, power off the ATM and power on.