

WORKMAN'S TENT DESCRIPTION AND USE

	CONTENTS	PAGE	1. GENERAL
1. GENERAL	1	1.01 This section covers the description and use of workman's tents.
2. DESCRIPTION	2	
3. PRECAUTIONS	4	1.02 This section is reissued to cover the method of placing D workman's tent on two (2) thirty-seven hole manhole racks, equipped with carriage bolts, to provide shelter for the craftsman when working in cable closures used in buried plant during inclement weather.
4. USE	4	
5. PLACING	5	
6. REMOVAL	11	
7. MAINTENANCE	11	1.03 The D workman's tent cover will accommodate two cables placed on opposite sides of a pole and the frame may be attached to the lower strand of a multicable lead. The B and C workman's tents do not have these features.
8. STORAGE	13	
9. SUPERSEDED TYPES	14	

NOTICE
This document is either
AT&T - Proprietary, or AT&T
TECHNOLOGIES, INC - Proprietary

Pursuant to Judge Greene's Order of August 5, 1983, beginning on January 1, 1984, AT&T will cease to use "BELL" and the Bell symbol, with the exceptions as set forth in that Order. Pursuant thereto, any reference to "BELL" and/or the BELL symbol in this document is hereby deleted and "expunged".

2. DESCRIPTION

2.01 The D workman's tent (Fig. 1) is a compact, lightweight, folding tent designed for

installation and removal by one man. The complete tent weighs about 30 pounds.

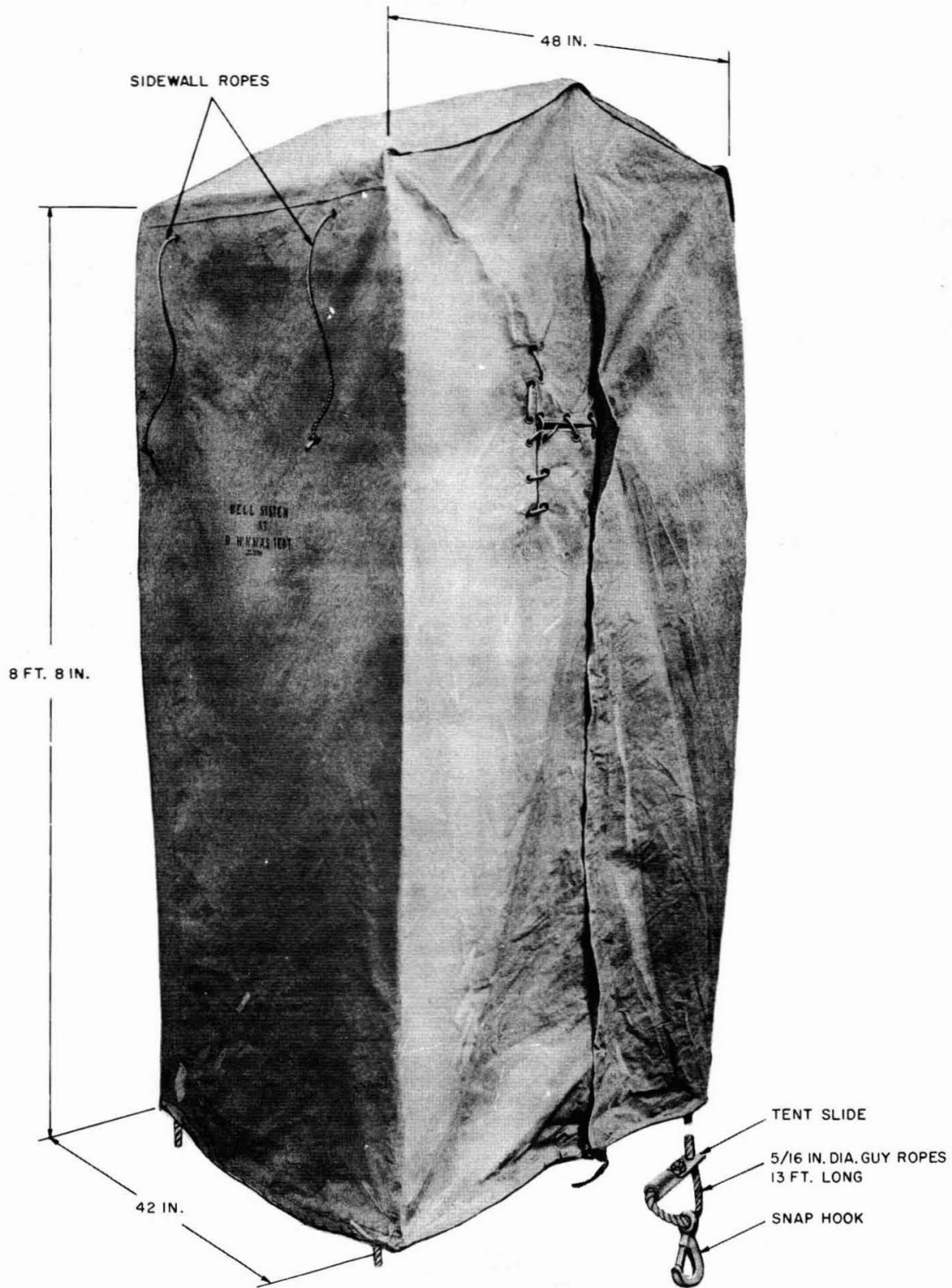

Fig. 1—D Workman's Tent

2.02 The cover of the tent is made of fire, water, mildew, and weather-resistant shelter-tent Army duck sides with a vinyl afterfinish and a translucent plastic top. The top, which is stitched securely to the sidewalls, provides adequate light for work operations.

2.03 The cover has a vertical opening on each side to accommodate aerial cable and to permit entrance and exit of workmen. The vertical openings may be closed securely with rope lacing. In addition, each vertical opening has a supplementary T-shaped opening to accommodate a second cable if two cables are supported on opposite sides of pole (Fig. 2).

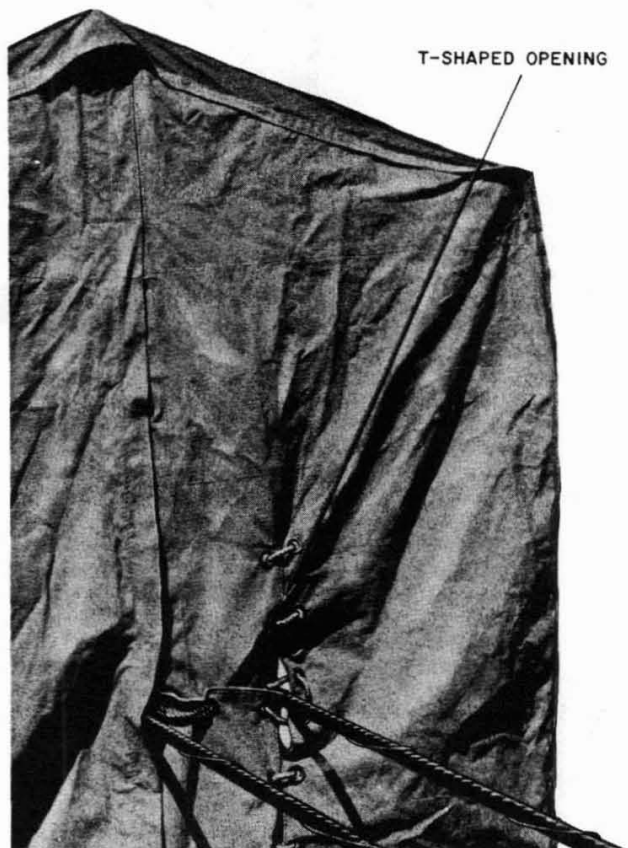

Fig. 2—Tent Mounted Showing Two Cables

2.04 The cover is provided with a drawstring in the bottom hem to permit gathering of the lower part of the tent to minimize drafts. The upper portion of the sidewalls is reinforced to reduce wear resulting from contact with ladder side rails, etc.

2.05 Two ropes in each sidewall provide a means of securing the sidewalls when they have been rolled up. Figure 3 illustrates the tent with the sidewalls rolled up and tied with the sidewall ropes.

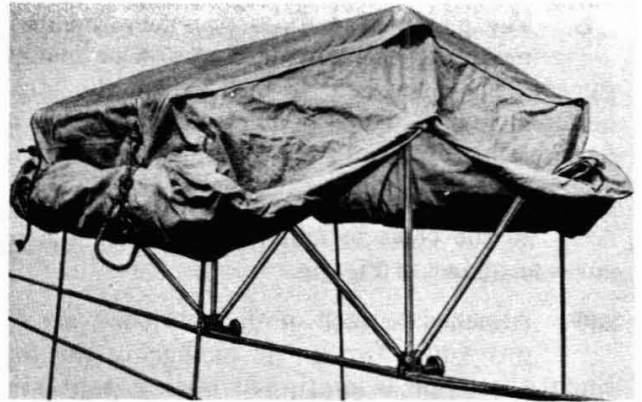

Fig. 3—Tent Sidewalls Rolled and Tied

2.06 The frame of the tent consists of three aluminum alloy bows which are hinged at the corners to allow the legs to be folded either when storing the tent or preparing it for placing. The legs of the bows are attached to a clamp assembly (Fig. 4). The legs of the center bow are rigidly attached to the clamp assembly while the legs of the two outer bows are hinged to the clamp assembly to permit these bows to be folded against the center bow when required. One of the side bows may be detached from the clamp assembly to permit the tent to be mounted on the lower strand of multicable leads. The bow can be detached from the clamps, passed over the upper cable, and reattached to the clamps, so that the upper cable passes through the tent between the center bow and the detachable bow of the frame.

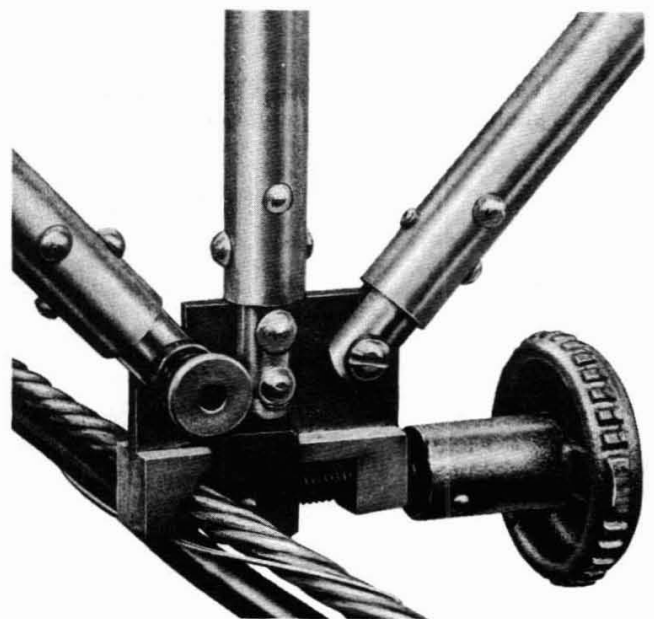

Fig. 4—Clamp Assembly

2.07 The clamp assemblies provide a means of mounting the tent on a strand or manhole guard. They are held in position on the strand or manhole guard by clamping screws which can be tightened by turning the knob on each clamp.

2.08 Two plastic-coated canvas straps are attached to the bows to minimize strain on the tent cover as shown in Fig. 14.

2.09 Attached to each of the side bows are two guy ropes for use in anchoring the tent. Each guy rope is equipped with a tent slide (tensioning device) and a snap hook to facilitate the placing and removal of the tent. The tent slide and snap hook are illustrated in Fig. 5.

3. PRECAUTIONS

3.01 Use a body belt and safety strap when working aloft.

3.02 *Exercise care when handling a tent to avoid contact with electric power wires and attachments.*

3.03 When placing the tent, do not untie the sidewall ropes until the guy ropes are secure. When removing the tent, roll up and tie the sidewalls before releasing the tension on the guy ropes. If the sidewalls should accidentally fall free during these operations when the guy ropes are not tensioned properly, the sail area presented could make the tent difficult to handle on a windy day.

4. USE

4.01 The D workman's tent is designed to provide shelter for outside plant forces.

4.02 The D workman's tent can be mounted on suspension strand, an extension ladder, or a standard manhole guard, or on two (2) 37-hole manhole racks equipped with $3/8 \times 4-1/2$ inch carriage bolts.

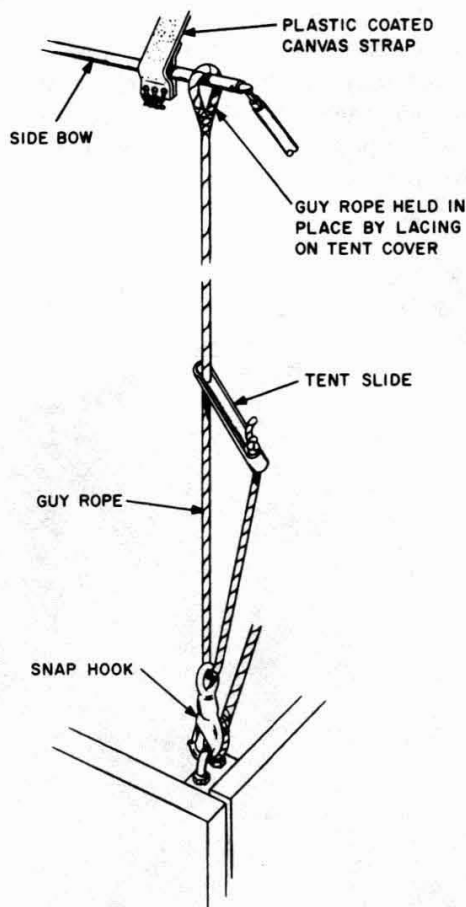

Fig. 5—Guy Rope Showing Tent Slide and Snap Hooks

5. PLACING

PLATFORM PLACING (SINGLE CABLE)

5.01 To prepare the tent for placing, lay it flat on the ground, fold the sides, roll up the sidewalls, and tie them with the sidewall ropes (Fig. 6). Before folding the legs parallel to the top secure the tent by tying it with the guy ropes. Fold the legs parallel to the top. The legs will be held in place by the handline.

5.02 With the handline block in place on the strand, tie one end of the handline around the folded tent at about the midpoint.

5.03 Climb the pole or ladder to the platform, secure the safety strap on the strand, raise the tent to the platform, remove the handline from the tent, and unfold the legs.

5.04 Position the tent on the platform so that the clamping screw knobs will be on the workman's side of the strand when the tent is placed on the strand. Remove the guy ropes from around the tent. Estimate the required length of the two guy ropes that will be secured on the opposite side of the strand from the workman and, using the tent slides, adjust the guy ropes to the estimated length. Secure the guy ropes by engaging the two snap hooks in the respective platform support rope U-bolts.

Note: The guy rope length should be sufficient to permit the top of the tent to lean slightly

beyond a vertical position toward the workman. If the guy ropes are too long, they will permit the tent to roll around the strand.

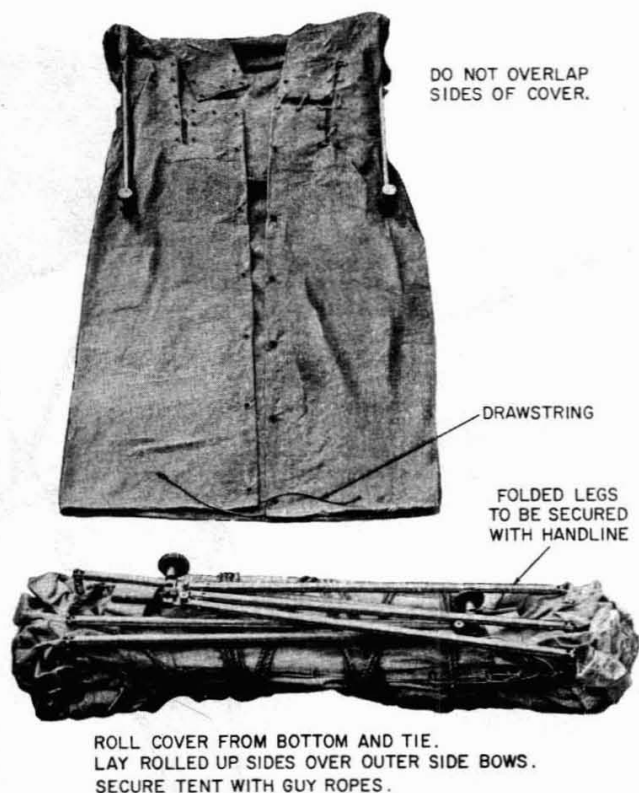

Fig. 6—Preparing D Workman's Tent for Placing or Storage

5.05 Raise the tent into position, engage the clamps on the strand, and tighten the clamping screws. Extend the roof by allowing

the side bows to drop into place. Figure 7 illustrates the tent with the roof extended and two guy ropes secured.



Fig. 7—Platform Placing of Tent—Partially Completed

5.06 Allow the tent to lean away from the two engaged guy ropes and toward the workman until it is supported in a position just beyond the vertical. Maintain the tent in this position by holding the other two guy ropes. Engage the snap hooks of the guy ropes in their respective platform support rope U-bolts and loosely tension the guy ropes.

5.07 To position the center bow vertically, retension all guy ropes. Untie the sidewall ropes, unroll the sidewalls, and lace the ends as required.

PLATFORM PLACING (MULTICABLE)

5.08 Handle the tent in the manner covered in 5.01 through 5.04. The detachable side bow may be passed over the upper strand after the tent is in position on the platform by *either* of two methods as follows:

- (a) Release the detachable side bow, pass it over the upper cable, and reattach it to the clamp assembly before the tent is raised into position on the strand and the clamps engaged.
- (b) Secure the clamp assembly to the lower strand and, while holding the tent in an upright position with one hand, disengage the detachable bow from the clamps and pass the legs of this bow over the upper cable and reattach them to the clamp assembly.

5.09 Allow the side bows to drop into place and proceed as outlined in 5.06 and 5.07. The

method of releasing the locking mechanism and the detachable side bow are shown in Fig. 8 and 9, respectively.

LADDER PLACING

5.10 Prepare the tent for use in the manner described in 5.01 except the tent slides and snap hooks may be removed from the guy ropes.

5.11 Tie one end of the handline around the folded tent at about the midpoint. Climb the ladder with the handline block, secure the safety strap on the strand, and engage the handline block on the strand.

5.12 Raise the tent, remove the handline from the tent, unfold the legs, and untie the guy ropes.

5.13 Raise the tent into position, engage the clamps on the strand, and tighten the clamping screws. Lean the tent back against the top of the ladder. Estimate the rear guy rope length and tie these two guy ropes temporarily on a ladder rung. Pull the tent into an upright position with the two front guy ropes and secure these ropes by tying them with half hitches to a ladder rung. The rear guy ropes, tied at the proper length, will prevent the tent from rolling around the strand. The front guy ropes should be tied to a ladder rung approximately 8 feet below the strand level. Retension the rear guy ropes and secure them on a ladder rung with half hitches.

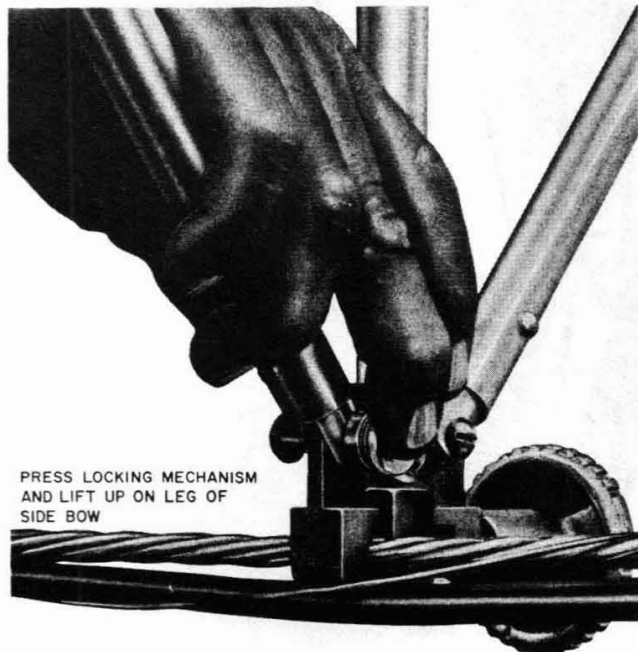

Fig. 8—Releasing Locking Mechanism

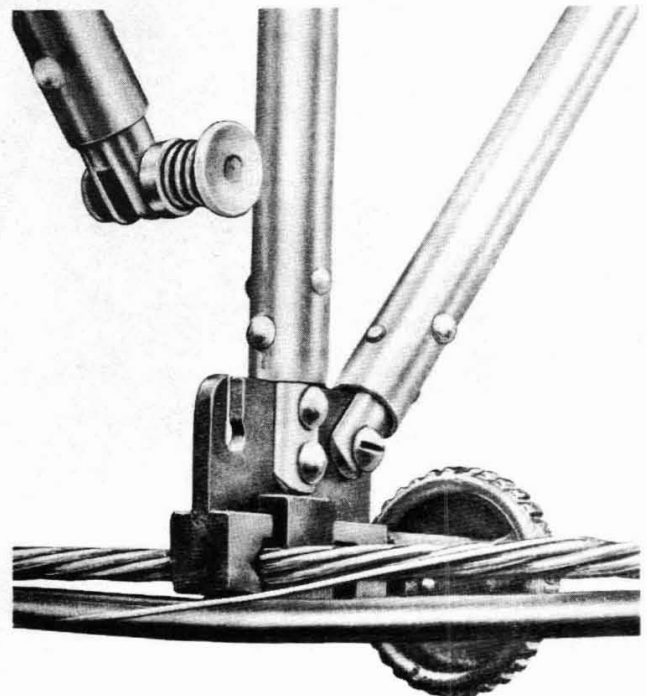

Fig. 9—Detachable Side Bow Released

SECTION 081-310-107

- 5.14** Untie the sidewall ropes, unroll the sidewalls, and lace the ends as required. Figure 10 illustrates the tent with the back sidewall unrolled and the front sidewall rolled up.

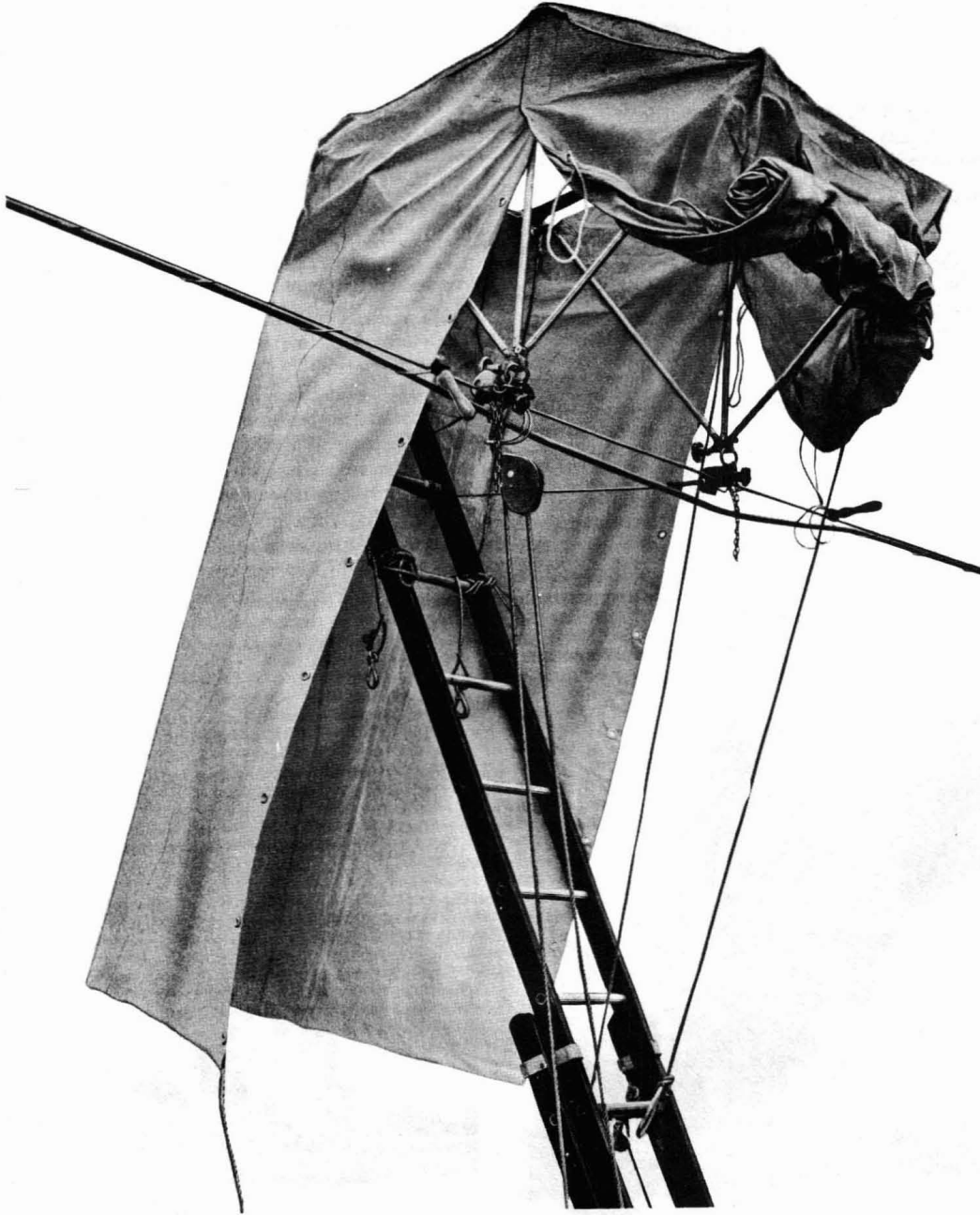

Fig. 10—D Workman's Tent Placed on Ladder

MANHOLE GUARD PLACING

5.15 Prepare the tent for mounting by rolling and tying the sides. It is not necessary to fold the legs or tie the tent with the guy ropes. The tent slides and snap hooks are not practical to use on a manhole guard and may be removed from the guy ropes.

5.16 Secure the manhole guard so it will not be blown over after the tent has been installed.

5.17 Raise the tent into position, engage the clamps on the tent loops of the manhole guard, and tighten the clamping screws.

5.18 Extend the roof by allowing the side bows to drop into place. Support the tent with one hand while tying the guy ropes to the lower rungs of the manhole guard with half hitches with the other hand.

5.19 Release the sidewall ropes and lace up the ends as required. Figure 11 illustrates the

tent mounted on a manhole guard with the back sidewall unrolled and the front sidewall rolled up.

5.20 The bottom of the back sidewall can be tied to the legs of the manhole guard to prevent the sidewall from flapping when the ends are not laced.

♦PLACING ON MANHOLE RACKS♦

5.21 ♦The following hardware items are required for placing D workman's tent on manhole racks:

- (a) two (2) 37-hole manhole racks
- (b) two (2) 3/8 × 4-1/2 inch carriage bolts
- (c) four (4) 3/8 inch nuts
- (d) four (4) 1/2 × 1-1/4 flat washers.♦



Fig. 11—D Workman's Tent Placed on Manhole Guard

5.22 ♦ Install the carriage bolts, nuts, and washers in one end hole of each 37-hole manhole rack as shown in Fig. 12.♦

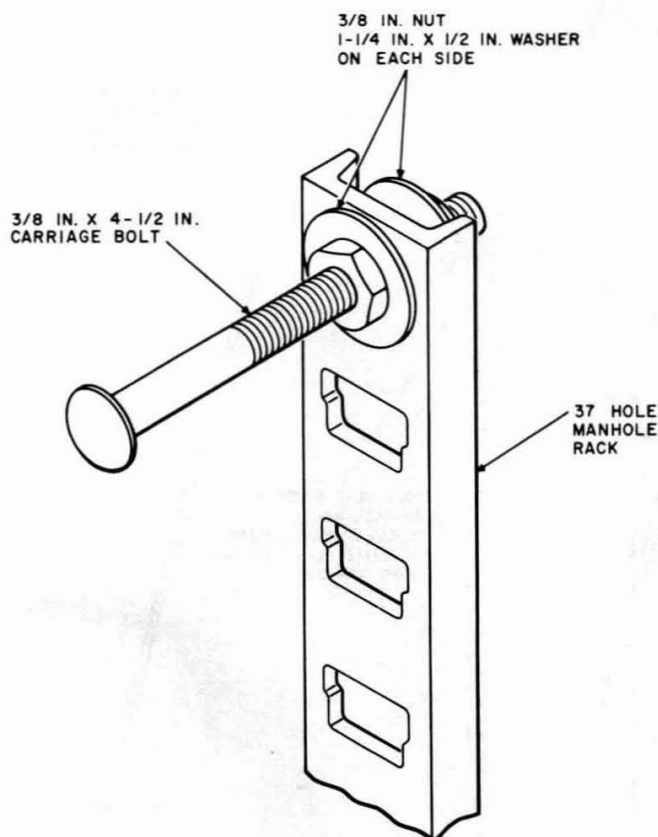

Fig. 12—♦Hardware Placed on Manhole Rack♦

5.23 ♦ Position the manhole racks so that heads of bolts are pointed away from work area, then drive the racks into the ground approximately 40 inches apart and 8 to 14 inches deep (Fig. 13). *Exercise extreme caution in selecting location for driving manhole rack to avoid the possibility of damaging buried cables.*♦

5.24 ♦ Set the D workman's tent clamp assembly on the carriage bolts and tighten by turning the knob on each clamp.♦

5.25 ♦ Unfold tent and fasten the guy ropes for maximum stability as shown in Fig. 13.♦

6. REMOVAL

6.01 Removal of a mounted tent is accomplished as follows:

- (a) If working aloft, attach the safety strap properly before proceeding with any work.
- (b) Roll up and tie both sidewalls with the sidewall ropes.
- (c) When working from a platform, stabilize the tent with one hand and slack off the guy ropes. Collapse the roof by drawing the bows together, loosen the clamping screws, and remove the tent from its mounting. If the tent is installed on the lower strand of a multicable lead, disengage the detachable bow from the clamp assemblies and pass this bow over the upper cable. Re-engage this bow with the clamp assembly. Disengage the guy rope snap hooks. When working from a ladder, untie the front guy ropes, lean the tent back against the top of the ladder, untie the rear guy ropes, loosen the clamping screws, and remove the tent from the strand.
- (d) Secure the tent by tying it with the guy ropes.
- (e) Fold the legs parallel to the top and attach the handline at about the midpoint of the folded tent. Lower the tent to the ground from the ladder or platform.

7. MAINTENANCE

7.01 Since each laundering removes some of the fireproofing, waterproofing, and life from the fabric, keep laundering of the tents to a minimum.

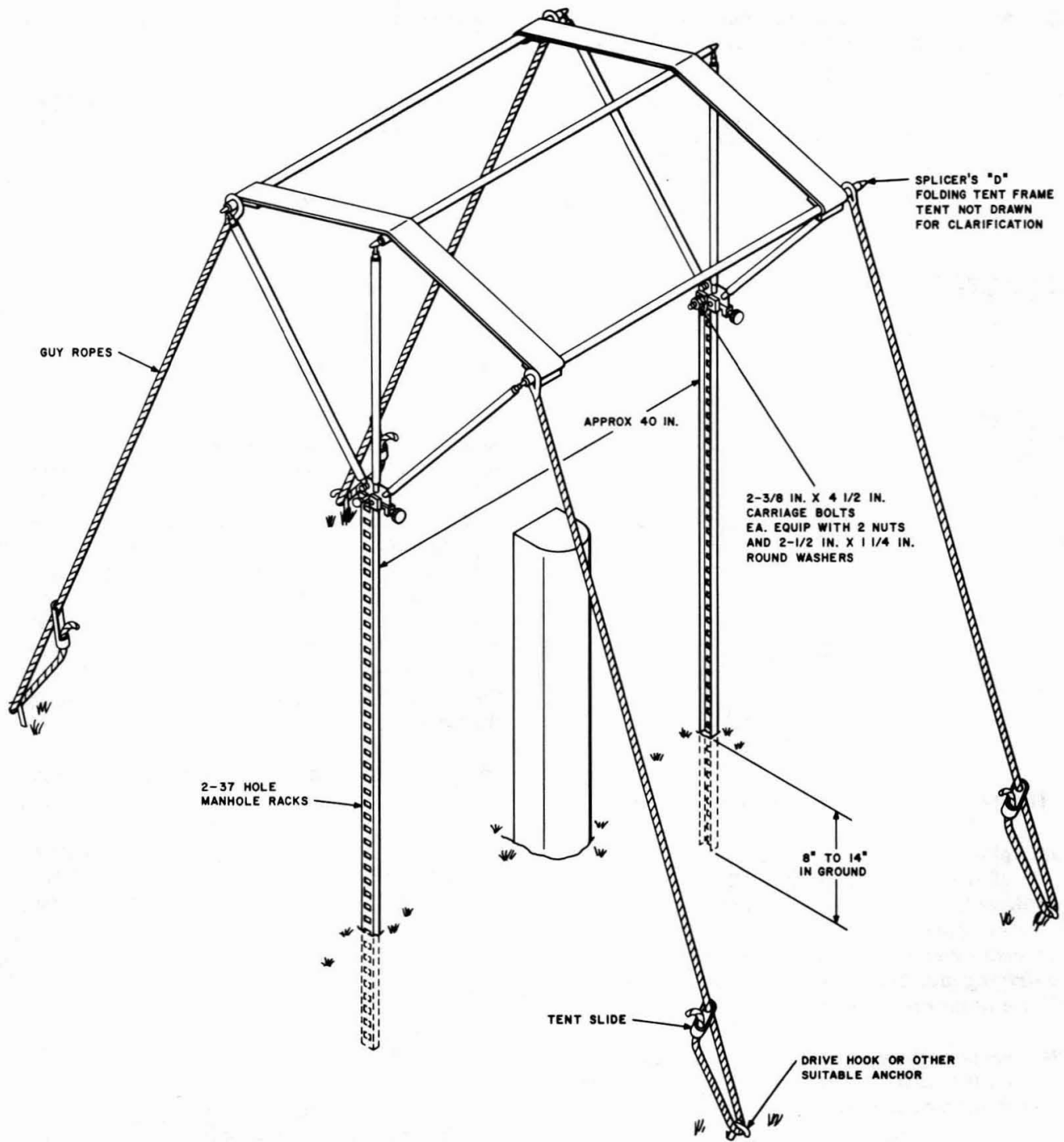

Fig. 13—D Workman's Tent Placed on Manhole Rack

7.02 To install a new cover on the tent frame:

- (a) Place the cover on the frame, making sure the straps are in the proper locations.
- (b) Lace the two tabs around the center bow. (Fig. 14—B).
- (c) On each side bow, lace the two tabs and the seam with a piece of rope 5 feet long. (Fig. 14—A and —C).

7.03 To install new plastic coated canvas straps, lace each strap to each of the three bows. A piece of lacing rope approximately two feet long is required for each lacing. (Fig. 14).

7.04 If a tent is in need of repair, handle it in accordance with local instructions.

7.05 Replacement parts are:

- (a) Cover and straps.
- (b) Rope, cotton, gray, 3/16-inch diameter 3 strand or No. 4 braided cotton or nylon venetian blind cord for lacing straps, tabs, and seams. Procure lacing rope locally.
- (c) Tent slides and snap hooks.
- (d) Guy ropes, 5/16-inch diameter.

8. STORAGE

8.01 To avoid punctures or tears, take care to keep the tent from coming in contact with sharp objects during use and storage.

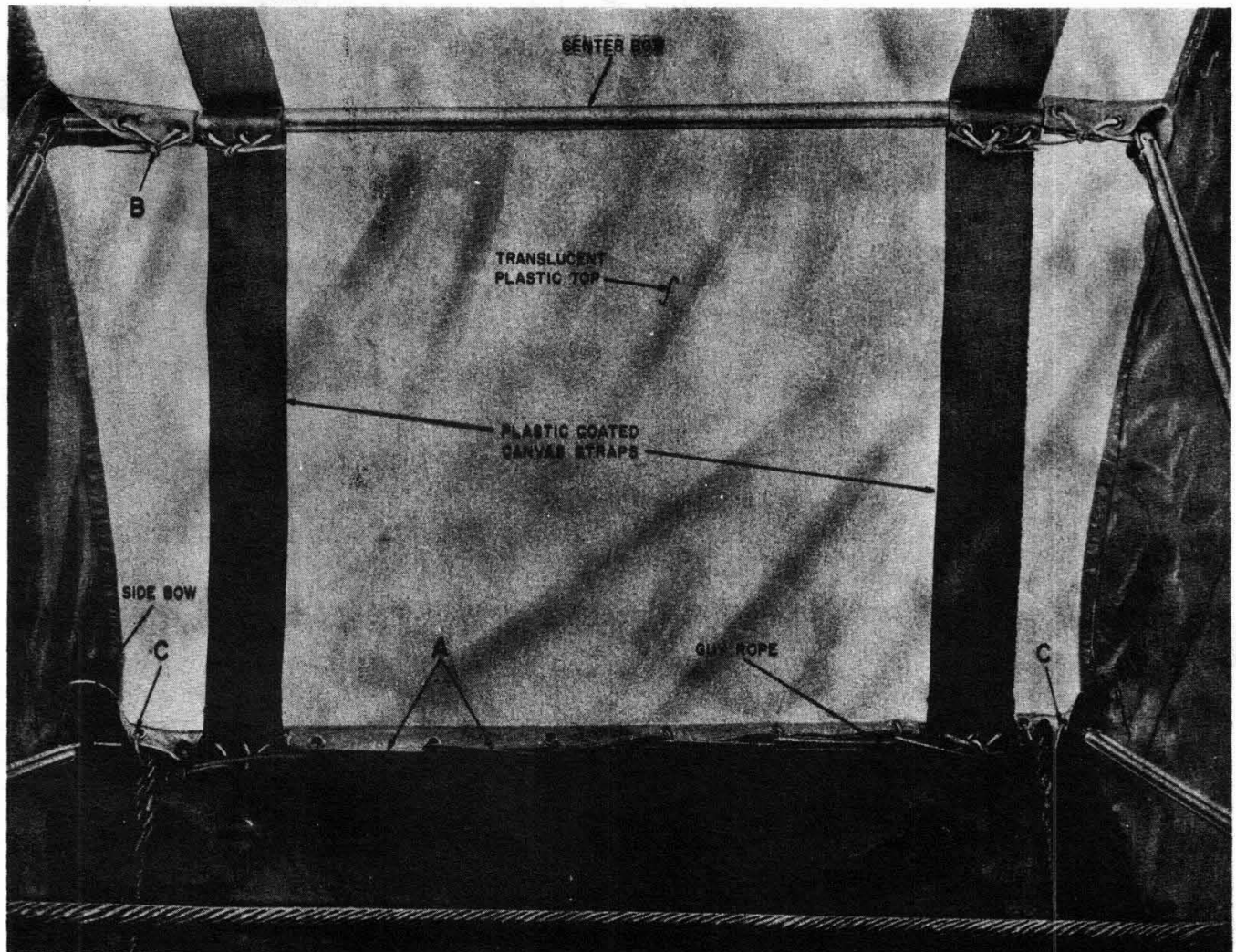

Fig. 14—Method of Lacing Cover and Straps to Bows

SECTION 081-310-107

8.02 To minimize soiling of the canvas and to protect the cover from damage, deep the tent in a B tent bag when not in use.

8.03 The tent should be dry before it is stored. At times it may be necessary to transport the tent when it is wet. If this is necessary, dry the tent at the first opportunity.

9. SUPERSEDED TYPES

9.01 The superseded C workman's tent and the B workman's tent are similar to the D

workman's tent and can be used as outlined in this practice.

9.02 Because of the construction of the frames of the superseded tents, they must be installed on the top strand where there is more than one strand in the lead (one strand above the other). The superseded B workman's tent and C workman's tent are shown in Fig. 15 and 16.

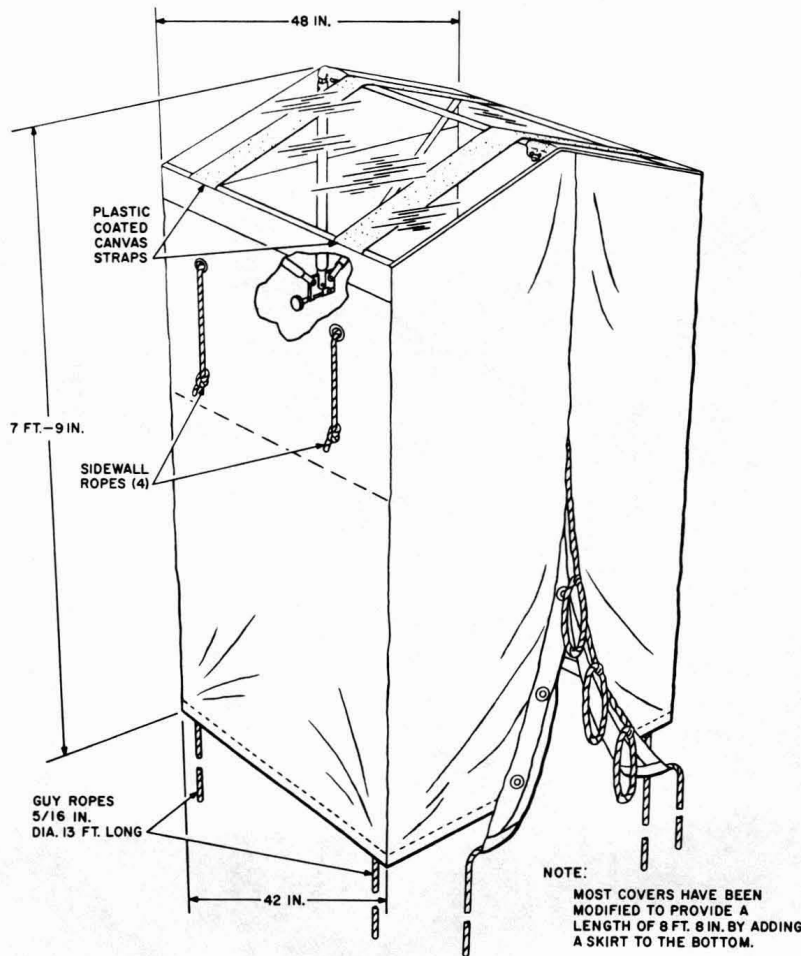

Fig. 15—Superseded B Workman's Tent

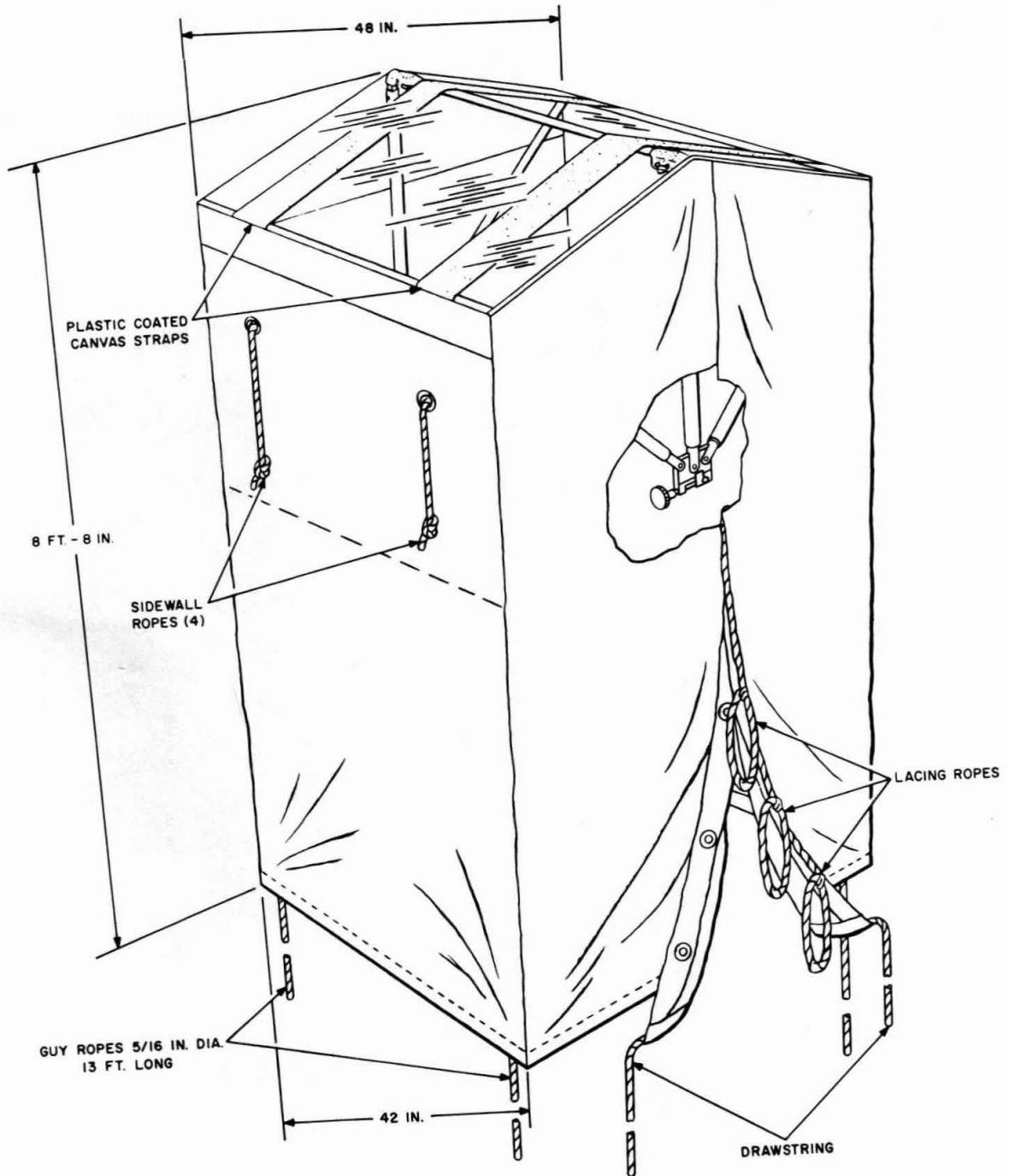

Fig. 16—Superseded C Workman's Tent